

Siconnect

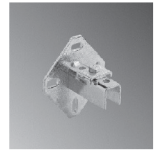

Izdaja 2015

Uprava in centralno skladišče

Sikla d.o.o.

Prekmurske čete 74

9232 Črenšovci

Telefon +386 (0)2 573 58 62 - centrala

Telefaks +386 (0)2 573 58 72

E-mail: info@sikla.si

Internet: www.sikla.si

KAZALO

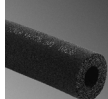
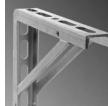
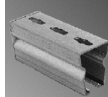

A

Adapter AD IG/IG	19
Adapter AD IG/IG VA	131
Adapter fiksna točka FPA	42
Adapter NT CC 41 DIN 3015	32
Adapter NT CC 41 DIN 3015 VA	135
Akustični element AKE	54
Alltape lepilni trak	124
Alu lamelni trak	123
Alu trak - BAL	24
Anker izolirni trak	123

B

Blok PB 27	85
Blok PB 41	31
Blok PBH 41	31
Blok set PBS CC 27	85

C

Centrirni sveder ZB	50
Cevna objemka RB-A črna	13
Cevna objemka RB-A HCP	146
Cevna zanka RSL N	19
Cevna zanka RSL N HCP	145
Cevno vpenjalo SCB	60
Climaflex CFX B1	113
Climaflex CFX B1 Stabil	114
Climaflex CFX B1 SV	114
Climaflex CFX izolacijska kapa	115
Coroplast 910 Alu-SE	125
Coroplast 918 Alu-lepilni trak	124

D

Denso trak 040	125
Denso trak KP	125
Denso trak WF	126
Distančna plošča DE	99
Distančnik za grelna telesa	78
Drсна objemka Ratio S-K	3
Drсни element GLE J	43
Drсни element GLE LC	43
Dršnik GS 1G	43
Dršnik GS 2G	43

Dršnik GS 2G VA	138
Dršnik GS 2G-PL	44
Dršnik GS 2G-PL VA	138
Dršnik GS 41	45
Dršnik GS 41 VA	139
Dršnik GS CC - 2G-PL	44
Dršnik GS CC - H3G-PL	45
Dršnik GS H3G	44
Dršnik GS H3G VA	138
Dršnik GS H3G-PL	44
Dršnik GS H3G-PL VA	138
Držalo MOF 27	87
Držalo profila SH	34
Držalo profila SH HCP	149
Držalo SHB HCP	151
Držalo za kabel KHP	30
Držna matica So-WK	39
Dvojna PP objemka	20
Dvojni navojni spojnik DOP	58
Dvojno privijalo DKG	121
Dvovijačnik DNFD	122

E

Element vezni za profil KL	33
Enojna PP objemka	20
Eurobatex AT Kleber	119
Eurobatex AT solar	118
Eurobatex C1 B1	116
Eurobatex C1 B1 izo. plošče	117
Eurobatex C1 lepilo	117
Eurobatex ETX C1 B1 rola	118
Eurobatex ETX C1 B1 rola SK	118
Eurobatex izolacijski trak	117

F

FE ventil PN 16 Ekskluziv	106
Fermat ventil	109
Fiksna točka - ravna plošča	81
Fiksna točka - vozliščna plošča	81

G

Gradbena tuljava OHA	101
Gradbeni čep BS - MD	100

Gradbeni čep BS - MSMD	101	KFE ventil 275 Solar	106
Gradbeni čep MS tesnilni	100	Klema za jekleno vrv DSL	27
Gravitacijska zapora SWK SFR	110	Klešče za luknjanje LOT	50
Gravitacijska zavora SWK	109	Klešče za PNS navojni zatič	66
H		Ključ za SDE 1	53
Hanger vijak BSCR brez vezi	57	Konzola za vertikalno SFK	92
Hanger vijak BSCR brez vezi VA	140	Kotna konzola WK	39
Hanger vijak BSCR z vezjo	57	Kotna konzola WK CC	39
Hartmetall-Wendeplatten HMWP-Set	100	Kotna konzola WK HCP	150
I		Kotni spojnik EV	35
Insul-Tube solar ITS	120	Kotni spojnik EW 41	36
Insul-Tube solar ITS SBD	120	Kotnik CN CC 27-90°	87
Izolacijska fiksna točka FKS	82	Kotnik CN CC 41 Stabil	38
Izolacijska objemka KSH / KSM	18	Kotnik CN CC 41-90°	37
Izolacijska objemka LKS H	14	Kotnik MW	38
Izolacijska objemka LKS M	15	Kotnik MW 90° W Stabil VA	137
Izolacijska objemka LKS T	16	Kotnik MW LL	38
Izolacijska objemka SKS	18	Kotnik MW S	38
Izolacijski trak BEB	24	Kovina/guma element GMT	54
Izpustni ventil ELV	106	Kroglični ventil KGH 300	101
Izpustni ventil KAH	103	Kroglični ventil KGH 380	101
Izrezna žaga LS	49	Kroglični ventil KGH 381	102
J		Kroglični ventil KGH 491	103
Jeklena vrv SDS	27	Kroglični ventil KGH 491 FM	103
K		Kroglični ventil KGH 593	103
Kanalna spona LCO	24	Kroglični ventil KGH 594	104
Kanalni kotnik LUW	25	L	
Kanalni kotnik LUW A	25	Laserska obdelava	97
Kanalni kotnik LUW F	25	Lepilni trak - dvostranski	97
Kapica ADK 27	86	Lesni vijak	59
Kapica ADK WK	40	Letev z napisom	95
Karabin KBR	28	Li-Ko vijaki LK	58
Kelinfix - izolacijska cev	112	Luknjalo LOT	51
Kelinfix - izolacijski trak	112	M	
Kelon - B1 izolacijske plošče	113	Magnetni nastavek MN	61
Kelon - izolacijski trak	115	Masa za sidranje MIT-Cool	70
Kelon B1 - izolacija v roli	114	Masa za sidranje VM-K	69
Kelon Climaflex B1 - lepilo	115	Masa za sidranje VMU	69
KFE ventil 275	105	Masa za sidranje VMU express	70
		Masa za sidranje VMZ	70
		Matica kljukasta NT CC 27	86

Matica kljukasta NT CC 41	31	Navojni zatič PNS	66
Matica kljukasta NT CC 41 HCP	147	Navojno streme RUB	20
Matica kljukasta NT CC 41 VA	135	navojno streme SB 27	88
Matica kljukasta NT HZ 41	32	NOMFIX	91
Matica kljukasta NT HZ 41 HCP	148	NOMIC DUO	91
Matica kljukasta NT HZ 41 VA	135	NOMIC DUOMAT	92
Matica narebričena N	64	NOMIC GRIP	91
Matica navojna NT	32	Nož za rezanje izolacije - veliki	119
Matica navojna NT 27	86		
Matica navojna NT VA	135	o	
Matica NT	63	Objemka fiksne točke FS	82
Matica NT HCP	153	Objemke	
Matica NT VA	141	Cevna objemka RB-A črna	13
Matica prirobna NT FLA	63	Cevna objemka RB-A HCP	146
Montažne klešče za ANC-M	69	Drсна objemka Ratio S-K	3
Montažni komplet MOS	35	Izolacijska fiksna točka FKS	82
Montažni komplet MOS CC	35	Izolacijska objemka AKS	17
Montažni komplet PBS CC 41	30	Izolacijska objemka KSH / KSM	18
Montažni kotnik MW HCP	149	Izolacijska objemka LKS H	14
Montažni kotnik MW S HCP	149	Izolacijska objemka LKS M	15
Montažni kotnik MW VA	137	Izolacijska objemka LKS T	16
Montažni profil MS 27 – 1,25	85	Izolacijska objemka SKS	18
Montažni profil MS 41 HCP	147	Objemka fiksne točke FS	82
Montažni profil MS VA	134	Prezrač. objemka Stabil D BSK	23
Montažni profili MS	29	Prezračevalna obj. PLU 2G-N b.o.	21
Montažni set MOS 27	87	Prezračevalna objemka TOP2G z o.	21
Multilogo MLG napisne tablice	104	Prezračevalna objemka-2G z o.	23
Multilogo MLG zaklj. pokrov	105	Ratio 3G	3
		Ratio LS	1
N		Ratio LS Silikon	2
Napenjalo SPSL M8	28	Ratio S	2
Nastavek BIT Torx 30	73	Ratio S M8	1
Nastavek za hanger vijake	57	Ratio S M8 / M10	1
Nastavek za izrezno žago	49	Stabil D	9
Navojna cev GR	67	Stabil D VA	128
Navojna cev GR HCP	154	Stabil D-1/2"	4
Navojna kljuka GH	48	Stabil D-1/2" z o.	5
Navojna palica BSK 5.8	67	Stabil D-1G HCP	143ff.
Navojna palica GST 4.6	66	Stabil D-1G VA	129
Navojna palica GST VA	142	Stabil D-1G VA Silikon	131
Navojni zatič GST HCP	153	Stabil D-1G VA z o.	130
Navojni zatič GST	65	Stabil D-3G	6

Stabil D-3G Silikon	8	Podaljšek vretena SVL 010	105
Stabil D-3G z o.	7	Podložka US	63
Stabil D-M16	10	Podložka US HCP	153
Stabil D-M16 Silikon	12	Podložka US VA	141
Stabil D-M16 z o.	11	Pokrov za profile MSA 41	30
Vijačna objemka SRS 2G	4	Povezovalni sklop VP A/B	83
Vijačna objemka SRS VA	127	Povezovalni sklop VP SDE 2	83
Vijačna objemka SRS VA z o.	127	Prazna letev SLL	95
Objemna konzola SKL	47	Prehodni kos AD AG/IG	64
Očesni vijak SCR	59	Prehodni kos AD IG/AG	85
Odzračevalnik ATR 124	108	Prehodni kos AD IG/AG VA	141
Odzračevalnik SE	108	Prekrivna matica NT SBE	110
Odzračevalnik SE-E	108	Previsna konzola AK	40
Oporna konzola ST	40	Previsna konzola AK 27	87
Opornik STR	40	Previsna konzola AK CC	41
Opornik STR VA	136	Previsna konzola AK HCP	151
Opozorilna tabla 100x50	97	Previsna konzola AK VA	137
Opozorilna tabla 200x100	98	Previsni vložek KD	49
Osnovna plošča GPL	41	Prezrač. objemka od DN 560	23
Osnovna plošča GPL HCP	149	Prezrač. objemka Stabil D BSK	23
Osnovna plošča GPL Siaqua	41	Prezrač. objemka z o. od DN 560	23
Osnovna plošča GPL VA	137	Prezračevalna obj. PLU 2G-N b.o.	21
Ozobje držno HK L 27	88	Prezračevalna obj. PLU Top-2G z o.	21
Ozobje kljukasto HK	33	Pribor VMZ / VMU / VM-K	70
Ozobje kljukasto HK 27	88	Priključna matica 3G	7
Ozobje kljukasto HK BL	34	Priključni kos ASS M16	31
Ozobje kljukasto HK HCP	148	Priklop za objemke SAD	30
Ozobje kljukasto HK VA	136	Pritrdilni set BFS	121
P		Pritrditev za streme HCP	146
PE vložni trak	55	Privarilna tablica UNI	93
Perforiran trak BND	26	Privijalna tablica SHT	93
Perforiran trak BND - cinkan	25	Privijalo VSB	121
Perforiran trak BND VA	134	Profilna guma SAL	26
Pištola za kit APP	78	Profilna guma SAL 27	88
Plastični vložek ANN	67	Profilna guma SAL SBR/EPDM	54
Plošča za dvojno držalo M8	57	Profilna guma SAL silikon	54
Ploščični vijak SCR	60	Profilna guma SAL SK	26
Podaljšek navojni AD IG/IG	64	Profilni teleskop ST 41	37
Podaljšek navojni AD IG/IG VA	141	Profilni žebelj PN 27	75
Podaljšek okrogli AD RD	64	Protimatica NT G	67
Podaljšek vretena SVL	102	Protimatica NT G HCP	154
		Prozoren pokrov SHA	94

PUR - čaše	122	Vijačno sidro MMS-ST	72
PUR univerzalno koleno	123	Sidrni vijak VMU-A	71
R		Sidrni vijak VMZ-A	71
Radiatorski odzračevalni čep	107	Sidro AN	73
Radiatorski reducirni čep HKRS	107	Sidro AN BZ plus	74
Radiatorski slepi čep HKBS	107	Sidro AN BZ plus A4	142
Rapid-W2	91	Sidro za votle strope AN	75
Ratio 3G	3	Sikla - standard	111
Ratio LS	1	Sikla - super	111
Ratio LS Silikon	2	Sikla-Plast lepilni trak	124
Ratio S	2	Siklafix - izolacijska cev	111
Ratio S M8	1	Silikonski kit SIK	78
Ratio S M8 / M10	1	SIMI Kotni priključek MS	99
Razcepnik za sidro ANT MSH	75	SIMI- Tesnilna manšeta	99
Razcepnik za udarno sidro ANT	75	Sklop za profile SK	34
Regulator višine HRS P	36	Sklop za profile SK HCP	148
Regulatur višine SDK	77	Sklop za profile SK-L HCP	149
Rezervno rezilo za nož	120	Spax vijaki SNK TG	58
Ročka za mehko zapiranje SSG	105	Spojnik CN CC 41	36
Rozeta HKR	78	Spojnik CN CC 41-2	36
S		Spona za nosilec TCS	47
S-obešalo SHK	28	Spona za nosilec TCS 41	47
Samolepilna guma MSK	55	Spona za nosilec TCS 41 HCP	152
Samorezni vijak SCR L	61	Spona za nosilec TCS HCP	152
Set fiksne točke FPK	81	Spona za nosilec TCS VA	139
SHARK-KR	92	Spona za prezrač. cevi LUB	24
Sidra		Stabil D VA	128
Profilni žebelj PN 27	75	Stabil D z o. za vertikalo SFK	92
Razcepnik za sidro ANT MSH	75	Stabil D-1/2"	4
Sidrni vijak VMU-A	71	Stabil D-1/2" z o.	5
Sidrni vijak VMZ-A	71	Stabil D-1G HCP	145
Sidro AN	73	Stabil D-1G VA	129
Sidro AN BZ plus	74	Stabil D-1G VA Silikon	131
Sidro AN BZ plus A4	142	Stabil D-1G VA z o.	130
Sidro za votle strope AN	75	Stabil D-2G/-3G Silikon VA	133
Udarno sidro AN	74	Stabil D-2G/-3G VA	132
Udarno sidro AN VA	142	Stabil D-2G/-3G z o. VA	132
Vijačna konzola RA	77	Stabil D-3G	6
Vijačno sidro MMS-I M8/M10	73	Stabil D-3G HCP	143
Vijačno sidro MMS-PR	72	Stabil D-3G Silikon	8
Vijačno sidro MMS-S	72	Stabil D-3G z o.	7
		Stabil D-3G z o. HCP	144

Stabil D-A	9	Vijačni set VSS	121
Stabil D-M16	10	Vijačno sidro MMS-I M8/M10	73
Stabil D-M16 Silikon	12	Vijačno sidro MMS-PR	72
Stabil D-M16 z o.	11	Vijačno sidro MMS-S	72
Stebelni vijak BOL M8	58	Vijačno sidro MMS-ST	72
Streme navojno RUB VA	134	Vijak matični MSR	50
Streme vpenjalno SB 41	49	Vijak s kladivasto glavo HM 27	86
		Vijak s kljuk. glavo HZ 41 HCP	148
		Vijak SCR FLA HCP	153
		Vijak z kljukasto glavo HZ 41	33
		Vijak z kljukasto glavo HZ41	136
		Vijak z vrtalno konjico SKB	60
		Vijak z zarezo SCR	60
		Vijaki	
		Hanger vijak BSCR brez vezi	57
		Hanger vijak BSCR brez vezi VA	140
		Hanger vijak BSCR z vezjo	57
		Lesni vijak	59
		Li-Ko vijaki LK	58
		Očesni vijak SCR	59
		Ploščični vijak SCR	60
		Samorezni vijak SCR L	61
		Spax vijaki SNK TG	58
		Ušesni vijak SCR LL	59
		Vijak s kljuk. glavo HZ 41 HCP	148
		Vijak SCR FLA HCP	153
		Vijak z vrtalno konjico SKB	60
		Vijak z zarezo SCR	60
		Šestrobi lesni vijak SKH	59
		Šestrobi lesni vijak SKH VA	140
		Šestrobi vijak SKT	62
		Šestrobi vijak SKT HCP	152
		Šestrobi vijak SKT VA	140
		Vložek iz medenine ANM	69
		Vložek sadaro - SDK	76
		Vložek SH	71
		Vložek z žebljem ANH	68
		Vložek za votle stene ANC-M	68
		Vložni trak - umetna masa EKS	55
		Vozliščne plošče KNO	35
		Vozliščne plošče KNO 27	89
		Vpenjalna kljuka SP	48
T			
Tablica LOG barvna, beli napis	96		
Tablica LOG barvna, črn napis	96		
Tablica z utori LOGN	95		
Tablice LOG - barvne	94		
Tesnilna masa DP 30/45	82		
Tkaninast trak 8200 silber	125		
Trak iz steklenih vlaken GSK	55		
Trak za profil SAL EPDM sk	56		
Trapezni nosilec TRH	50		
U			
Udarni sornik za PN	75		
Udarni sornik za SDK Sadaro	76		
Udarno sidro AN	74		
Udarno sidro AN ES	74		
Udarno sidro AN VA	142		
UNI z vpenjalnim trakom	93		
Univerzačni vložek ANU	68		
UP izolacijski trak PE	112		
UP Stabil - izolacijska cev	111		
Ušesni vijak SCR LL	59		
V			
Varovalo SL VdS	47		
Ventil 3-potni krog. KGH 181 T	102		
Ventil KGH 376 z izpustom	102		
Ventil KGH 594 Multilogo	104		
Veriga GLK	27		
Vezni kotnik FLW	25		
Vgrezni vijak SCR	6		
Vijačna konzola PLE	77		
Vijačna objemka SRS 2G	4		
Vijačna objemka SRS VA	127		
Vijačna objemka SRS VA z o.	127		

Vpenjalni nastavek P	48	Zvočni dušilec SDE 0	53
Vpenjalni nastavek P HCP	152	Zvočni dušilec SDE 1	53
Vpenjalni nastavek P VA	139	Zvočni dušilec SDE 2	53
Vpenjalni trak LOH	94	Zvočni dušilec SDE 2 - FP 1	54
Vtisk	97	Zvočni dušilec SDE 2 - SBV/SBZ	53
		Zvočni dušilec SDE 2 - UG 16	53
		Zvočno izolacijski element 27	89
		Zvočno izolacijski element SDE	26
		UNI brez vpenjalnega traku	93
W		Č	
WBD držalo	37	Čep iz medenine MSP	99
WBD držalo C HCP	150	Čistilo	119
WBD Držalo HCP	150	Člen za spajanje SGL	28
WBD držalo VA	136		
WC - Pritrditev WCB	79	Š	
WT - Pritrditev WTB	79	Šestrobi lesni vijak SKH	59
		Šestrobi lesni vijak SKH VA	140
Z		Šestrobi vijak SKT	62
Zaključna kapica ADK	29	Šestrobi vijak SKT HCP	152
Zanka za jekleno vrv DSK	27	Šestrobi vijak SKT VA	140
Zapora za hidrav. udar RSV 235	109	Štiri robni ključ za odzrač.	107
Zglob JOI 41 HCP	151		
Zglob JOI 41 T HCP	151		
Zglob univerzalni UG	48		
Zglob univerzalni UG VA	139		
Zvočna zaščita za Sadaro	76		

2 Cevne objemke in pribor

Ratio S M8	1
Ratio S M8 / M10	1
Ratio LS	1
Ratio LS Silikon	2
Ratio S	2
Drсна objemka Ratio S-K	3
Ratio 3G	3
Vijačna objemka SRS 2G	4
Stabil D-1/2"	4
Stabil D-1/2" z o.	5
Stabil D-3G	6
Vgrezni vijak SCR	6
Priključna matica 3G	7
Stabil D-3G Silikon	8
Stabil D-A	9
Stabil D-M16	10
Stabil D-M16 z o.	11
Stabil D-M16 Silikon	12
Cevna objemka RB-A	13
Izolacijska objemka LKS H	14
Izolacijska objemka LKS M	15
Izolacijska objemka LKS T	16
Izolacijska objemka AKS	17
Izolacijska objemka KSH / KSM	18
Izolacijska objemka SKS	18
Adapter AD IG/IG	19
Cevna zanka RSL N	19
Navojno streme RUB	20
Woeste – enojna PP objemka	20
Woeste – dvojna PP objemka	20

3 Pritrditev prezračevalnih kanalov

Prezračevalna obj. PLU Top-2G z o.	21
Prezračevalna obj. PLU 2G-N b.o.	21
Prezrač. objemka od DN 560	23
Prezrač. objemka Stabil D BSK	23
Spona za prezrač. cevi LUB	24
Kanalna spona LCO	24
Alu trak - BAL	24
Izolacijski trak BEB	24
Kanalni kotnik LUW	25

Kanalni kotnik LUW A	25
Vezni kotnik FLW	25
Perforiran trak BND - cinkan	25
Perforiran trak BND	26
Zvočno izolacijsli element SDE	26
Profilna guma SAL	26
Profilna guma SAL SK	26
Veriga GLK	27
Jeklena vrv SDS	27
Zanka za jekleno vrv DSK	27
Klema za jekleno vrv DSL	27
Člen za spajanje SGL	28
S-obešalo SHK	28
Karabin KBR	28
Napenjalo SPSL M8	28

4 Montažni profili in pribor

Montažni profili MS	29
Zaključna kapica ADK	29
Pokrov za profile MSA 41	30
Držalo za kabel KHP	30
Montažni komplet PBS CC 41	30
Priklop za objemke SAD	30
Blok PBH 41	31
Blok PB 41	31
Priključni kos ASS M16	31
Matica kljukasta NT CC 41	31
Matica kljukasta NT HZ 41	32
Matica navojna NT	32
Adapter NT CC 41 DIN 3015	32
Vijak z kljukasto glavo HZ 41	33
Element vezni za tirnice KL	33
Ozobje kljukasto HK	33
Ozobje kljukasto HK BL	34
Sklop za profile SK	34
Držalo profila SH	34
Montažni komplet MOS	35
Montažni komplet MOS CC	35
Vozliščne plošče KNO	35
Kotni spojnik EV	35
Kotni spojnik EW 41	36
Spojnik CN CC 41-2	36

Spojnik CN CC 41	36	Vpenjalni nastavek P	48
Regulator višine HRS P	36	Navojna kljuka GH	48
5 Konzole, osnovne plošče in montažni kotniki	37	Vpenjalna kljuka SP	48
WBD-Držalo	37	Streme vpenjalno SB 41	49
Profilni teleskop ST 41	37	Previsni vložek KD	49
Kotnik CN CC 41-90°	37	Izrezna žaga LS	49
Kotnik CN CC 41 Stabil	38	Nastavek za izrezno žago	49
Kotnik MW S	38	Centrirni sveder ZB	50
Kotnik MW LL	38	Trapezni nosilec TRH	50
Kotnik MW	38	Vijak matični MSR	50
Kotna konzola WK	39	Klešče za luknjanje LOT	50
Kotna konzola WK CC	39	Luknjalo LOT	51
Držna matica So-WK	39	8 Zvočno izolacijski elementi	53
Kapica ADK WK	40	Zvočni dušilec SDE 0	53
Opornik STR	40	Zvočni dušilec SDE 1	53
Oporna konzola ST	40	Ključ za SDE 1	53
Previsna konzola AK	40	Zvočni dušilec SDE 2	53
Previsna konzola AK CC	41	Zvočni dušilec SDE 2 - SBV/SBZ	53
Osnovna plošča GPL	41	Zvočni dušilec SDE 2 - FP 1	54
Osnovna plošča GPL Siaqua	41	Akustik-element AKE	54
Adapter fiksna točka FPA	42	Kovina/guma element GMT	54
6 Drsniki	43	Profilna guma SAL SBR/EPDM	54
Drсни element GLE LC	43	Profilna guma SAL silikon	54
Drсни element GLE J	43	Samolepilna guma MSK	55
Drsnik GS 1G	43	Trak iz steklenih vlaken GSK	55
Drsnik GS 2G	43	PE – Vložni trak	55
Drsnik GS 2G-PL	44	Vložni trak-umetna masa EKS	55
Drsnik GS CC - 2G-PL	44	9 Vijaki, sidra in pribor	57
Drsnik GS H3G	44	Hanger vijak BSCR z vezjo	57
Drsnik GS H3G-PL	44	Hanger vijak BSCR brez vezi	57
Drsnik GS CC - H3G-PL	45	Nastavek za hanger vijake	57
Drsnik GS 41	45	Plošča za dvojno držalo M8	57
7 Pritrditev za nosilce in trapezno ploščevino	47	Stebelni vijak BOL M8	58
Objemna konzola SKL	47	Dvojni navojni spojnik DOP	58
Spona za nosilec TCS	47	Li-Ko vijaki LK	58
Spona za nosilec TCS 41	47	Spax vijaki SNK TG	58
Varovalo SL VdS	47	Šestrobi lesni vijak SKH	59
Zglob univerzalni UG	48	Lesni vijak	59
		Ušesni vijak SCR LL	59
		Očesni vijak SCR	59

Ploščični vijak SCR	60	Sidro AN	73
Cevno vpenjalo SCB	60	Sidro AN BZ plus	74
Vijak z zarezo SCR	60	Udarno sidro AN	74
Vijak z vrtalno konjico SKB	60	Udarno sidro AN ES	74
Samorezni vijak SCR L	61	Razcepnik za udarno sidro ANT	75
Magnetni nastavek MN	61	Razcepnik za sidro ANT MSH	75
Šestrobi vijak SKT	62	Sidro za votle strope AN	75
Podložka US	63	Profilni žebelj PN 27	75
Matica NT	63	Udarni sornik za PN	75
Matica prirobna NT FLA	63	Vložek sadaro - SDK	76
Matica narebričena N	64	Udarni sornik za SDK Sadaro	76
Podaljšek navojni AD IG/IG	64	Regulatur višine SDK	77
Podaljšek okrogli AD RD	64	Brunata-Vijačna konzola RA	77
Prehodni kos AD IG/AG	64	Brunata- Vijačna konzola PLE	77
Navojna reducirka AD AG/IG	65	Kotna konzola WK z zvočno izolacijo	77
Navojni zatič GST	65	Distančnik za grelna telesa	78
Navojni zatič PNS	66	Rozeta HKR	78
Klešče za PNS navojni zatič	66	Silikonski kit SIK	78
Navojna palica GST	66	Pištola za kit APP	78
Navojna palica BSK	67	WC-Pritrditev WCB	79
Navojna cev GR	67	WT-Pritrditev WTB	79
Protimatica NT G	67		
Plastični vložek ANN	67	10 Fiksne točke	81
Univerzačni vložek ANU	68	Set fiksne točke FPK	81
Vložek z žeblijem ANH	68	Fiksna točka-vozliščna plošča	81
Vložek za votle stene ANC-M	68	Fiksna točka-ravna plošča	81
Montažne klešče za ANC-M	69	Objemka fiksne točke FS	82
Vložek iz medenine ANM	69	Izolacijska fiksna točka FKS	82
Masa za sidranje VM-K	69	Tesnilna masa DP 30/45	82
Masa za sidranje VMU	69	Povezovalni sklop VP A/B	83
Masa za sidranje VMU express	70	Povezovalni sklop VP SDE 2	83
Masa za sidranje MIT-Cool	70		
Masa za sidranje VMZ	70	11 Sistem Pressix CC 27	85
Pribor VMZ / VMU / VM-K	70	Montažni profil MS 27 – 1,25	85
Vložek SH	71	Blok set PBS CC 27	85
Sidrni vijak VMU-A	71	Blok PB 27	85
Sidrni vijak VMZ-A	71	Prehodni kos AD IG/AG	85
Vijačno sidro MMS-ST	72	Matica kljukasta NT CC 27	86
Vijačno sidro MMS-S	72	Matica navojna NT 27	86
Vijačno sidro MMS-PR	72	Vijak s kladivasto glavo HM 27	86
Nastavek BIT Torx 30	73	Kapce ADK 27	86
Vijačno sidro MMS-I M8/M10	73	Kotnik CN CC 27-90°	87

Previsna konzola AK 27	87	SIMI- Tesnilna manšeta	99
Montažni set MOS 27	87	Set obračalnih plošč za rezkalo	100
Držalo MOF 27	87	Gradbeni čep MS tesnilni	100
Navojno streme SB 27	88	Gradbeni čep BS - MD	100
Ozobje kljukasto HK 27	88	Gradbeni čep BS - MSMD	101
Ozobje držno HK L 27	88	Gradbena tuljava OHA	101
Profilna guma SAL 27	88	Kroglični ventil KGH 300	101
Zvočnoizolacijski element 27	89	Kroglični ventil KGH 380	101
Vozliščne plošče KNO 27	89	Kroglični ventil KGH 381	102
12 Cevni spojniki	91	Ventil KGH 376 z izpustom	102
NOMIC DUO	91	Podaljšek vretena SVL	102
Rapid-W2	91	Ventil 3-potni krog. KGH 181 T	102
NOMIC GRIP	91	Izpustni ventil KAH	103
NOMFIX	91	Kroglični ventil KGH 491	103
NOMIC DUOMAT	92	Kroglični ventil KGH 491 FM	103
SHARK-KR	92	Kroglični ventil KGH 593	103
Konzola za vertikalno SFK	92	Kroglični ventil KGH 594	104
Stabil D z o. za vertikalno SFK	92	Ventil KGH 594 Multilogo	104
13 Označevalne tablice	93	Multilogo MLG napisne tablice	104
UNI z vpenjalnim trakom	93	Multilogo MLG zaklj. pokrov	105
Univerzalna tablica UNI brez vpenjalnega traku	93	Podaljšek vretena SVL 010	105
Privarilna tablica UNI	93	Ročka za mehko zapiranje SSG	105
Privijalna tablica SHT	93	KFE-Ventil 275	105
Vpenjalni trak LOH	94	KFE-Ventil 275 Solar	106
Prozoren pokrov SHA	94	FE-Ventil PN 16 Ekskluziv	106
Tablice LOG - barvne	94	Izpustni ventil ELV	106
Tablica z utori LOGN	95	Radiatorski reducirni čep HKRS	107
Prazna letev SLL	95	Radiatorski odzračevalni čep	107
Letev z napisom	95	Radiatorski slepi čep HKBS	107
Tablica LOG barvna, beli napis	96	Štiri robni ključ za odzračē.	107
Tablica LOG barvna, črn napis	96	Odzračevalnik SE	108
Lepilni trak - dvostranski	97	Odzračevalnik SE-E (kotni)	108
Vtisk	97	Odzračevalnik ATR 124	108
Laserska obdelava	97	Fermat-ventil	109
Opozorilna tabla 100x50	97	Zapora za hidrav. udar RSV 235	109
Opozorilna tabla 200x100	98	Gravitacijska zavora SWK	109
14 Armature	99	Prekrivna matica NT SBE	110
SIMI-Kotni priključek MS	99	Gravitacijska zapora SWK SFR	110
Čep iz medenine MSP	99	15 Izolacija	111
Distančna plošča DE	99	Sikla-standard	111
		Sikla-super	111

Siklafix-izolacijska cev	111	Denso trak WF	126
UP-Stabil-Izolacijska cev	111		
Kelinflix-Izolacijska cev	112	16 Nerjaveče jeklo	127
UP- Izolacijski trak PE	112	Vijačna objemka SRS VA	127
Kelinflix-Izolacijski trak	112	Vijačna objemka SRS VA z o.	127
Climaflex CFX B1	113	Stabil D - VA	128
Kelon-B1 Izolacijske plošče	113	Stabil D-1G VA	129
Kelon-B1-Izolacija v roli	114	Stabil D-1G VA z o.	130
Climaflex CFX B1 SV	114	Stabil D-1G VA Silikon	131
Climaflex CFX B1 Stabil	114	Adapter AD IG/IG VA	131
Climaflex CFX Izolacijska kapa	115	Stabil D-2G/-3G VA	132
Kelon-Izolacijski trak	115	Stabil D-2G/-3G z o. VA	132
Kelon-Climaflex-B1-Lepilo	115	Stabil D-2G/-3G Silikon VA	133
Eurobatex C1 B1	116	Streme navojno RUB VA	134
Eurobatex C1 B1 izo. plošče	117	Perforiran trak BND VA	134
Eurobatex Izolacijski trak	117	Montažni profil MS VA	134
Eurobatex C1 lepilo	117	Matica kljukasta NT CC 41 VA	135
Eurobatex ETX C1 B1 rola	118	Matica kljukasta NT HZ 41 VA	135
Eurobatex ETX C1 B1 rola SK	118	Matica navojna NT VA	135
Eurobatex AT solar	118	Adapter NT CC 41 DIN 3015 VA	135
Eurobatex AT Kleber	119	Vijak z kljukasto glavo HZ41	136
Čistilo	119	Ozobje kljukasto HK VA	136
Nož za rezanje izolacije - veliki	119	Opornik STR VA	136
Rezervno rezilo za nož	120	WBD-Držalo VA	136
Insul-Tube solar ITS	120	Kotnik MW 90° W Stabil VA	137
Insul-Tube-solar ITS SBD	120	Montažni kotnik MW VA	137
Vijačni set VSS	121	Previsna konzola AK VA	137
Pritrdilni set BFS	121	Osnovna plošča GPL VA	137
Privijalo VSB	121	Drsnik GS 2G VA	138
Dvojno privijalo DKG	121	Drsnik GS 2G-PL VA	138
Dvovijačnik DNFD	122	Drsnik GS H3G VA	138
PUR-čase	122	Drsnik GS H3G-PL VA	138
PUR-univerzalno koleno	123	Drsnik GS 41 VA	139
Alu-Lamelni trak	123	Spona za nosilec TCS VA	139
Anker izolirni trak	123	Vpenjalni nastavek P VA	139
Alltape-lepilni trak	124	Zglob univerzalni UG VA	139
Sikla-Plast-lepilni trak	124	Šestrobi lesni vijak SKH VA	140
Coroplast 918 Alu-lepilni trak	124	Šestrobi vijak SKT VA	140
Coroplast 910 Alu-SE	125	Podložka US VA	141
Tkaninast trak 8200 silber	125	Matica NT VA	141
Denso trak 040	125	Podaljšek navojni AD IG/IG VA	141
Denso trak KP	125	Prehodni kos AD IG/AG VA	141

Navojna palica GST VA	142	Sklop za profile SK-L HCP	149
Sidro AN BZ plus A4	142	Držalo profila SH HCP	149
Udarno sidro AN VA	142	Osnovna plošča GPL HCP	149
17 HCP zaščita materiala	143	Montažni kotnik MW HCP	149
Stabil D-3G HCP	143	Montažni kotnik MW S HCP	149
Stabil D-3G z o. HCP	144	Kotna konzola WK HCP	150
Stabil D-1G HCP	145	WBD-Držalo HCP	150
Cevna zanka RSL N HCP	145	WBD-Držalo C HCP	150
Cevna objemka RB-A HCP	146	Držalo SHB HCP	151
Pritrditev za streme HCP	146	Previsna konzola AK HCP	151
Montažni profil MS 41 HCP	147	Zglob JOI 41 T HCP	151
Matica kljukasta NT CC 41 HCP	147	Zglob JOI 41 HCP	151
Matica kljukasta NT HZ 41 HCP	148	Spona za nosilec TCS HCP	152
Vijak s kljukasto glavo HZ 41 HCP	148	Spona za nosilec TCS 41 HCP	152
Ozobje kljukasto HK HCP	148	Vpenjalni nastavek P HCP	152
Sklop za profile SK HCP	148	Šestrobi vijak SKT HCP	152
		Vijak SCR FLA HCP	153

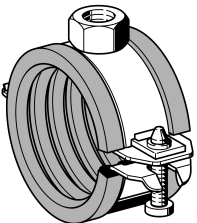
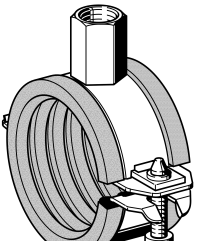
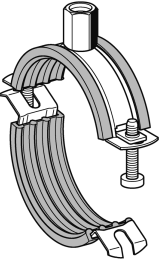
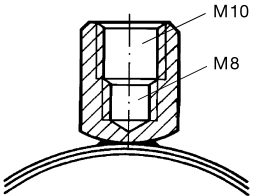
Stran	Produkt	Artikel	Pakirano	Artikel-št.	
2-4	Ratio S M8 	Skupina: 1234			
		10 - 12	10/12 mm	100	166669
		13 - 16	15 mm	100	157339
		17 - 19	$\frac{3}{8}$ "	100	157366
		20 - 24	$\frac{1}{2}$ "	100	157348
		25 - 30	$\frac{3}{4}$ "	100	157357
		31 - 38	1"	100	157320
		40 - 46	1 $\frac{1}{4}$ "	50	157311
		48 - 53	1 $\frac{1}{2}$ "	50	157302
		58 - 63	2"	50	191864
2-5	Ratio S M8 / M10 	Skupina: 1229			
		13 - 16	15 mm	100	402601
		17 - 19	$\frac{3}{8}$ "	100	402610
		20 - 24	$\frac{1}{2}$ "	100	402619
		25 - 30	$\frac{3}{4}$ "	100	402628
		31 - 38	1"	100	402637
		40 - 46	1 $\frac{1}{4}$ "	50	402646
		48 - 51	1 $\frac{1}{2}$ "	50	402655
		58 - 63	2"	50	191927
		2-6	Ratio LS  	Skupina: 1245	
12 - 20	$\frac{1}{4}$ " - $\frac{3}{8}$ "			100	157418
21 - 27	$\frac{1}{2}$ " - $\frac{3}{4}$ "			100	157427
28 - 35	1"			100	157436
38 - 45	1 $\frac{1}{4}$ "			50	157445
48 - 56	1 $\frac{1}{2}$ "			50	157454
57 - 63	2"			50	157463
64 - 71				25	157472
74 - 84	2 $\frac{1}{2}$ "			25	157481
83 - 90 *	3"			25	157490
108 - 114	4"	25	157506		

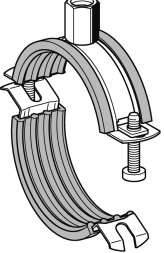
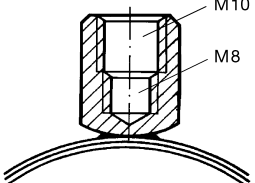
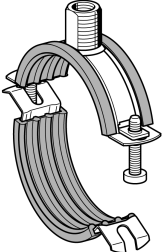
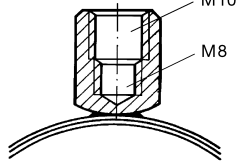
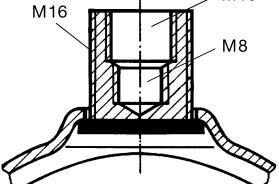

Stran	Produkt	Artikel	Pakirano	Artikel-št.			
2-8	<p>Ratio LS Silikon</p>  	Skupina: 1244					
		12 - 20	$\frac{1}{4}'' - \frac{3}{8}''$	100	166401		
		21 - 27	$\frac{1}{2}'' - \frac{3}{4}''$	100	166410		
		28 - 35	1"	100	166429		
		38 - 45	1 $\frac{1}{4}''$	50	166438		
		48 - 56	1 $\frac{1}{2}''$	50	166447		
		57 - 63	2"	50	166456		
		64 - 71		25	166465		
		74 - 84	2 $\frac{1}{2}''$	25	166474		
		83 - 90	3"	25	166483		
		2-9	<p>Ratio S</p>  <p>12 - 35 mm</p>  <p>38 - 170 mm</p> 	Skupina: 1231			
				12 - 20	$\frac{1}{4}'' - \frac{3}{8}''$	100	154804
				21 - 27	$\frac{1}{2}'' - \frac{3}{4}''$	100	154813
28 - 35	1"			100	154822		
38 - 45	1 $\frac{1}{4}''$			50	154831		
48 - 56	1 $\frac{1}{2}''$			50	154840		
57 - 63	2"			50	154859		
64 - 71				25	154868		
73 - 80	2 $\frac{1}{2}''$			25	154877		
83 - 90	3"			25	154886		
108 - 114	4"			25	154895		
116 - 125				25	154901		
127 - 135				25	154910		
140 - 146	5"	25	154929				
159 - 170	6"	25	154938				

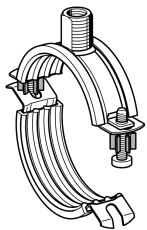
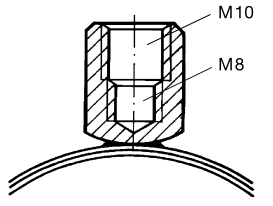
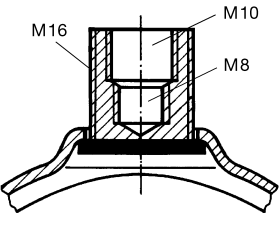
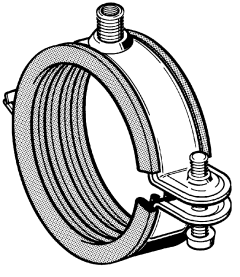
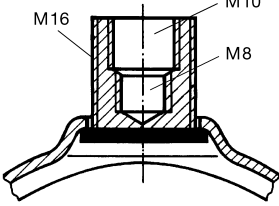
Stran	Produkt	Artikel	Pakirano	Artikel-št.		
2-11	<p>Drсна objemka Ratio S-K</p>  <p>16 - 32 mm</p>  <p>40 - 110 mm</p> 	Skupina: 1235				
		16	100	148771		
		20	100	148780		
		25	100	148799		
		32	100	148805		
		40	50	148814		
		50	50	148823		
		56	50	148832		
		63	50	148841		
		75	25	148850		
		90	25	155993		
		110	25	156000		
		2-12	<p>Ratio 3G</p>  	Skupina: 1237		
				13 - 16	15	100
17 - 19	$\frac{3}{8}$ "			100	120528	
20 - 23	$\frac{1}{2}$ "			100	120537	
25 - 30	$\frac{3}{4}$ "			100	120546	
31 - 37	1"			100	120555	
40 - 45	$1 \frac{1}{4}$ "			50	120564	
48 - 53	$1 \frac{1}{2}$ "			50	120573	
54 - 59	57			50	120582	
60 - 64	2"			50	120591	
70 - 76	$2 \frac{1}{2}$ "			25	120616	
77 - 83	83			25	120625	
83 - 90	3"			25	120634	
108 - 114	4"			25	120652	
133 - 141	5"			25	120661	
159 - 168	6"			25	120670	

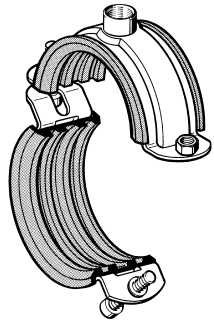

Stran	Produkt	Artikel	Pakirano	Artikel-št.
2-13	Vijačna objemka SRS 2G	Skupina: 1223		
		13 - 18	100	173216
		19 - 22	100	173225
		23 - 26	100	111470
		27 - 30	100	173234
		32 - 36	100	173243
		40 - 44	50	173252
		48 - 54	50	173261
		55 - 59	50	182990
		60 - 66	50	173279
		68 - 73	25	173288
		75 - 80	25	173297
		84 - 89	25	173306
		90 - 98	25	186023
		94 - 101	25	186032
		102 - 108	25	173315
		110 - 115	25	173324
		118 - 125	25	186041
		129 - 136	25	191387
		138 - 144	25	191396
		144 - 153	25	191405
		159 - 167	25	191414
2-14	Stabil D-1/2"	Skupina: 1220		
		20 - 24	50	400927
		25 - 30	50	400936
		31 - 35	50	400945
		40 - 45	50	400963
		48 - 53	50	400972
		54 - 59	50	402007
		60 - 65	50	400999
		67 - 72	50	401008
		76 - 81	25	401026
		88 - 93	25	401044
		102 - 108	25	401071
		110 - 116	10	401080
		124 - 129	10	401089
		133 - 140	10	401098
		140 - 148	10	401107
		149 - 155	10	401116
		159 - 165	10	402025
		167 - 173	10	401134
		176 - 184	10	401143
		188 - 194	10	412006
		199 - 205	10	401152
		205 - 214	10	412015
		219 - 225	10	412024
		244 - 250	10	412033
		267 - 273	10	412042
		278 - 284	10	412051
		297 - 303	10	412060

Stran	Produkt	Artikel	Pakirano	Artikel-št.
2-15	Stabil D-1/2" z o.	Skupina: 1220		
		19 - 23 1/2"	50	401386
		24 - 28 3/4"	50	401395
		33 - 37 1"	50	401404
		40 - 45 1 1/4"	50	401413
		47 - 52 1 1/2"	50	401422
		53 - 58	50	401431
		60 - 65 2"	50	401449
		67 - 72	25	401467
		73 - 78 2 1/2"	25	401476
		79 - 85	25	401485
		88 - 93 3"	25	401494
		100 - 106	25	401503
		108 - 115 4"	10	402088
		124 - 129	10	401530
		131 - 137	10	401539
		138 - 144 5"	10	401548
		148 - 154	10	401557
		156 - 162	10	401566
		165 - 171 6"	10	401575
		177 - 183	10	412150
		188 - 194	10	412159
		196 - 203	10	402097
		205 - 214	10	412168
		219 - 225 8"	10	412177
	244 - 250	10	412186	
	267 - 273 10"	10	412195	
	299 - 305	10	412204	

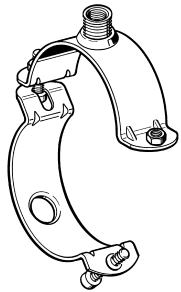
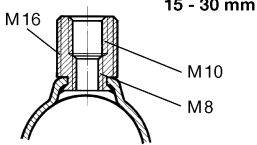
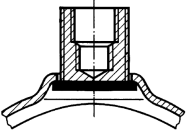
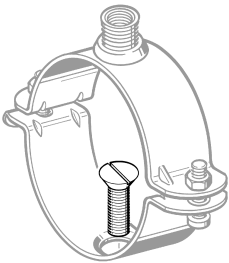

Stran	Produkt	Artikel	Pakirano	Artikel-št.
2-16	<p>Stabil D-3G</p>   <p>15 - 30 mm</p>  <p>31 - 72 mm: M16/M10/M8 76 - 129 mm: 3/8"/M12/M10 133 - 316 mm: 1/2"/M16/M12</p>	<p>Skupina: 1240</p> <p>15 - 19 3/8"</p> <p>20 - 24 1/2"</p> <p>25 - 30 3/4"</p> <p>31 - 35 1"</p> <p>40 - 45 1 1/4"</p> <p>48 - 53 1 1/2"</p> <p>54 - 59 2"</p> <p>60 - 65 2"</p> <p>67 - 72 2 1/2"</p> <p>76 - 81 2 1/2"</p> <p>82 - 87 3"</p> <p>88 - 93 3"</p> <p>102 - 108 4"</p> <p>110 - 116 4"</p> <p>124 - 129 5"</p> <p>133 - 140 5"</p> <p>140 - 148 6"</p> <p>149 - 155 6"</p> <p>159 - 165 8"</p> <p>167 - 173 8"</p> <p>176 - 184 10"</p> <p>188 - 194 10"</p> <p>199 - 205 10"</p> <p>207 - 216 10"</p> <p>219 - 225 10"</p> <p>244 - 250 10"</p> <p>267 - 273 10"</p> <p>278 - 284 10"</p> <p>297 - 303 10"</p> <p>310 - 316 10"</p>		
			50	107705
			50	107714
			50	107723
			50	107015
			50	107024
			50	107033
			50	107042
			50	107051
			50	107060
			25	107079
			25	107088
			25	107097
			25	107103
			25	107112
			25	107121
			10	107130
			10	115885
			10	107149
			10	107158
			10	107167
			10	107176
			10	107185
			10	107194
			10	148939
			10	107200
			10	107219
			10	107228
			10	107237
			10	107246
			10	147600
2-18	<p>Vgrezni vijak SCR</p> 	<p>Skupina: 1333</p> <p>M8 x 20</p>	100	114097

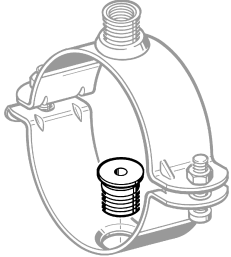
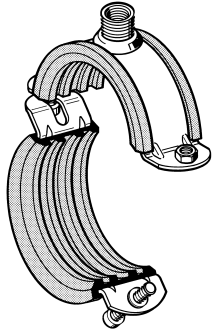
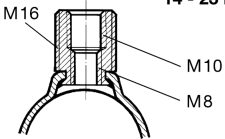
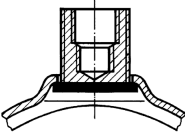
Stran	Produkt	Artikel	Pakirano	Artikel-št.
2-18	Priključna matica 3G	Skupina: 1333 M16/M10/M8	50	146326
				
2-19	Stabil D-3G z o.	Skupina: 1241		
		14 - 18 $\frac{3}{8}$ "	50	107680
		19 - 23 $\frac{1}{2}$ "	50	107699
		24 - 28 $\frac{3}{4}$ "	50	107255
		29 - 33 1"	50	107264
		33 - 37	50	107273
		40 - 45 $1 \frac{1}{4}$ "	50	107282
		47 - 52 $1 \frac{1}{2}$ "	50	107291
		53 - 58	50	107307
		60 - 65 2"	50	107316
		67 - 72	25	107325
		73 - 78 $2 \frac{1}{2}$ "	25	107334
		79 - 85	25	107343
		88 - 93 3"	25	107352
		100 - 106	25	107361
		108 - 115 4"	25	107370
		124 - 129	10	107389
		131 - 137	10	107398
		138 - 144 5"	10	107404
		148 - 154	10	107413
		156 - 162	10	107422
		165 - 171 6"	10	107431
		177 - 183	10	107440
		188 - 194	10	107459
		196 - 203	10	148911
		205 - 214	10	148920
		219 - 225 8"	10	107468
		244 - 250	10	107477
		267 - 273 10"	10	107486
		299 - 305	10	107495
		307 - 318 *	10	189974
				
	14 - 23 mm			
	24 - 65 mm: M16/M10/M8			
	67 - 115 mm: $\frac{3}{8}$ "/M12/M10			
	124 - 318 mm: $\frac{1}{2}$ "/M16/M12			

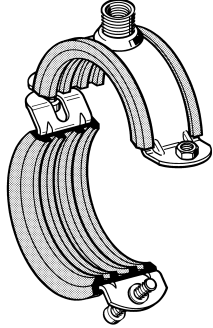
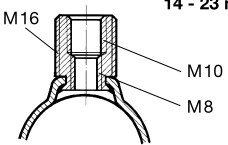
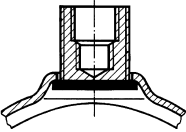

Stran	Produkt	Artikel	Pakirano	Artikel-št.
2-21	Stabil D-3G Silikon	Skupina: 1242		
	 <p>14 - 23 mm</p>  <p>M16 M10 M8</p> <p>24 - 65 mm: M16/M10/M8 67 - 115 mm: 3/8"/M12/M10 124 - 305 mm: 1/2"/M16/M12</p> 	14 - 18 $\frac{3}{8}$ "	50	108070
		19 - 23 $\frac{1}{2}$ "	50	108089
		24 - 28 $\frac{3}{4}$ "	50	108098
		29 - 33 1"	50	108104
		33 - 37	50	108113
		40 - 45 $1 \frac{1}{4}$ "	50	108122
		47 - 52 $1 \frac{1}{2}$ "	50	108131
		53 - 58	50	108140
		60 - 65 2"	50	108159
		67 - 72	25	108168
		73 - 78 $2 \frac{1}{2}$ "	25	108177
		79 - 85	25	108186
		88 - 93 3"	25	108195
		100 - 106	25	108201
		108 - 115 4"	25	108210
		124 - 129	10	108229
		131 - 137	10	108238
		138 - 144 5"	10	108274
		148 - 154	10	108283
		156 - 162	10	108292
		165 - 171 6"	10	108308
		177 - 183	10	108317
		188 - 194	10	108326
		196 - 203	10	154947
		205 - 214	10	149879
		219 - 225 8"	10	108335
		244 - 250	10	108344
		267 - 273 10"	10	108353
	299 - 305	10	108362	

Stran	Produkt	Artikel	Pakirano	Artikel-št.
2-23	Stabil D-A	Skupina: 1239		
		15 - 19 $\frac{3}{8}$ "	50	107732
		20 - 24 $\frac{1}{2}$ "	50	107741
		25 - 30 $\frac{3}{4}$ "	50	107750
		31 - 35 1"	50	113371
		40 - 45 $1 \frac{1}{4}$ "	50	113368
		48 - 53 $1 \frac{1}{2}$ "	50	113369
		54 - 59	50	113370
		60 - 65 2"	50	113371
		67 - 72	50	113372
		76 - 81 $2 \frac{1}{2}$ "	25	113373
		82 - 87	25	113374
		88 - 93 3"	25	113375
		102 - 108	25	113376
		110 - 116 4"	25	113377
		124 - 129	25	113378
		133 - 140	10	113379
		140 - 148 5"	10	113380
		149 - 155	10	113381
		159 - 165	10	113382
		167 - 173 6"	10	113383
		176 - 184	10	113384
		188 - 194	10	113385
		199 - 205	10	113386
		207 - 216	10	113387
		219 - 225 8"	10	113388
		244 - 250	10	113389
		267 - 273 10"	10	113390
		278 - 284	10	113391
	297 - 303	10	113392	
	316 - 324 324	1	103701	
	348 - 356 356	1	103729	
	360 - 368 368	1	103747	
	399 - 407 407	1	103765	
	411 - 419 419	1	103783	
	500 - 508 508	1	103808	
	513 - 521 521	1	103826	



Stran	Produkt	Artikel	Pakirano	Artikel-št.
2-25	Stabil D-M16	Skupina: 1232		
		19 - 23	50	118268
		26 - 30	50	118277
		33 - 38	50	118295
		39 - 44	50	118301
		45 - 50	50	118310
		54 - 58	50	118329
		60 - 64	50	118338
		65 - 72	25	118620
		70 - 77	25	118639
		85 - 92	25	118648
		97 - 104	25	118657
		105 - 108	25	104058
		110 - 117	25	118666
		118 - 125	25	400343
		122 - 129	25	118684
		133 - 140	10	118693
		148 - 155	10	118709
		158 - 165	10	118718
		168 - 175	10	118727
		173 - 180	10	118736
		188 - 195	10	118745
		195 - 202	10	118754
		208 - 215	10	118763
		218 - 227	10	118772
		228 - 235	10	118781
		245 - 252	10	118790
		258 - 265	10	118806
		271 - 277	10	400344
		285 - 291	10	118204
		316 - 324	1	103844
		348 - 356	1	103862
		360 - 368	1	103871
		399 - 407	1	103905
	411 - 419	1	103914	
	500 - 508	1	103941	
	513 - 521	1	103950	

Stran	Produkt	Artikel	Pakirano	Artikel-št.
2-26	Stabil D-M16 z o.	Skupina: 1213		
		15 - 19	50	401584
		19 - 22	50	401593
		26 - 30	50	401611
		33 - 38	50	401620
		38 - 42	50	401629
		44 - 50	50	401638
		51 - 58	50	401647
		58 - 63	50	401656
		63 - 71	25	401665
		75 - 85	25	115663
		88 - 94	25	115672
		98 - 105	25	401683
		100 - 112	25	401692
		114 - 116	25	401701
		121 - 135	10	115715
		139 - 145	10	115724
		145 - 153	10	115733
		154 - 161	10	115742
		160 - 168	10	115751
		176 - 181	10	115760
		193 - 200	10	115788
		204 - 213	10	115797
		214 - 221	10	115803
		244 - 251	10	115821
		271 - 277	10	118222
		298 - 310	2	401710
		315 - 324	1	103987
		345 - 356	1	103996
		359 - 368	1	104003
		398 - 407	1	104012
	410 - 419	1	104021	
	498 - 508	1	104030	
	512 - 521	1	104049	

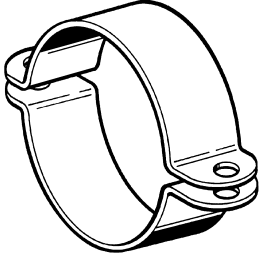

Stran	Produkt	Artikel	Pakirano	Artikel-št.
2-27	Stabil D-M16 Silikon	Skupina: 1214		
		15 - 19	50	408308
		19 - 22	50	408317
		26 - 30	50	408326
		33 - 38	50	408335
		38 - 42	50	408344
		44 - 50	50	408353
		51 - 58	50	408362
		58 - 63	50	408371
		63 - 71	25	408380
		75 - 85	25	408389
		88 - 94	25	408407
		98 - 105	25	408416
		100 - 112	25	408425
		114 - 116	25	408434
		121 - 135	10	408443
		139 - 145	10	408452
		145 - 153	10	408461
		154 - 161	10	408470
		160 - 168	10	408479
		176 - 181	10	408488
		193 - 200	10	408497
		204 - 213	10	408506
		214 - 221	10	408515
		244 - 251	10	408524
		271 - 277	10	408533
		298 - 310	2	408542
		315 - 324	1	146007
		345 - 356	1	146016
		359 - 368	1	146025
		398 - 407	1	146034

Stran	Produkt	Artikel	Pakirano	Artikel-št.
2-28	Cevna objemka RB-A črna	Skupina: 1260		
		13 - 18	25	110309
		17 - 22	25	110310
		23 - 27	25	110312
		30 - 34	25	110403
		34 - 38	25	110314
		40 - 44	25	110404
		45 - 49	25	110316
		57 - 61	25	110319
		66 - 70	25	110320
		73 - 77	25	110321
		85 - 89	25	110322
		90 - 104	10	110323
		103 - 109	10	110324
		109 - 115	10	110325
		119 - 133	10	110327
		134 - 140	10	110328
		156 - 162	10	111733
		163 - 169	10	110330
		188 - 194	1	110332
		214 - 220	1	110335
		248 - 254	1	110336
		261 - 267	1	110337
		265 - 273	1	110338
		316 - 324	1	110341
		350 - 356	1	110342
		360 - 368	1	110343
		402 - 407	1	110344
		412 - 419	1	110345
		450 - 457	1	110346
		501 - 508	1	110347
		512 - 521	1	110348
	529 - 535	1	110442	
	603 - 610	1	110443	

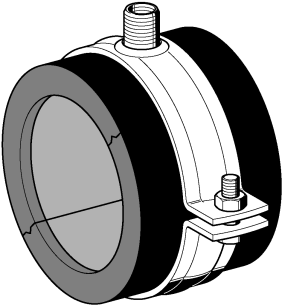

Stran	Produkt	Artikel	Pakirano	Artikel-št.		
2-29	Izolacijska objemka LKS H	Skupina: 1255			Izolacija (cm)	
		LKS H-15	M8/M10	48	184916	13.0
		LKS H-16	M8/M10	48	416327	13.0
		LKS H-18	M8/M10	48	184925	13.0
		LKS H-20	M8/M10	36	416335	13.0
		LKS H-22	M8/M10	36	184934	13.0
		LKS H-25	M8/M10	30	184943	13.0
		LKS H-26	M8/M10	30	416328	13.0
		LKS H-28	M8/M10	30	184952	13.5
		LKS H-30	M8/M10	30	184961	13.5
		LKS H-32	M8/M10	30	416329	13.5
		LKS H-35	M8/M10	30	184970	13.5
		LKS H-38	M8/M10	30	184979	14.0
		LKS H-40	M8/M10	24	416330	14.0
		LKS H-42	M8/M10	24	184988	14.0
		LKS H-44	M8/M10	24	184997	14.0
		LKS H-48	M8/M10	24	185006	14.0
		LKS H-50	M8/M10	24	416336	14.0
		LKS H-54	M8/M10	24	185015	14.0
		LKS H-57	M8/M10	24	185024	15.0
		LKS H-60	M8/M10	24	185033	15.0
		LKS H-64	M8/M10	18	185042	15.0
		LKS H-70	M8/M10	18	185051	15.0
		LKS H-76	M8/M10	18	185060	15.0
		LKS H-80	M8/M10	18	185069	15.0
		LKS H-89 A	M10/M12 ³ / ₈ "	12	416435	17.5
		LKS H-108 A	M12/M16 ¹ / ₂ "	10	416436	17.5
		LKS H-110 A	M12/M16 ¹ / ₂ "	10	416337	17.5
		LKS H-114 A	M12/M16 ¹ / ₂ "	10	416437	17.5
		LKS H-125 A	M12/M16 ¹ / ₂ "	8	416338	21.0
		LKS H-133 A	M12/M16 ¹ / ₂ "	6	416438	21.0
		LKS H-139	M12/M16 ¹ / ₂ "	6	185123	16.0
		LKS H-160	M12/M16 ¹ / ₂ "	6	185132	16.0
		LKS H-168	M12/M16 ¹ / ₂ "	6	185141	16.0

Stran	Produkt	Artikel	Pakirano	Artikel-št.		
2-31	Izolacijska objemka LKS M	Skupina: 1255			Izolacija (cm)	
		LKS M-15	M8/M10	42	185150	19.0
		LKS M-16	M8/M10	42	416570	19.0
		LKS M-18	M8/M10	42	185159	19.5
		LKS M-20	M8/M10	42	416588	19.5
		LKS M-22	M8/M10	42	185168	19.5
		LKS M-25	M8/M10	42	185177	19.5
		LKS M-26	M8/M10	42	416571	19.5
		LKS M-28	M8/M10	36	185186	20.0
		LKS M-30	M8/M10	36	185195	20.0
		LKS M-32	M8/M10	36	416572	20.0
		LKS M-35	M8/M10	24	185204	20.0
		LKS M-38	M8/M10	24	185213	21.5
		LKS M-40	M8/M10	24	416573	21.5
		LKS M-42	M8/M10	24	185222	21.5
		LKS M-44	M8/M10	24	185231	21.5
		LKS M-48	M8/M10	18	185240	21.5
		LKS M-50	M8/M10	18	416589	21.5
		LKS M-54	M8/M10	18	185249	21.5
		LKS M-57	M8/M10	18	185258	22.0
		LKS M-60	M8/M10	18	185267	22.0
		LKS M-64	M8/M10	18	185276	22.0
		LKS M-70	M8/M10	18	185285	22.0
		LKS M-76	M8/M10	18	185294	22.0
		LKS M-80	M8/M10	18	185303	22.0
		LKS M-89 A	M12/M16 ^{1/2} "	10	416471	22.0
		LKS M-108 A	M12/M16 ^{1/2} "	8	416472	25.5
		LKS M-110 A	M12/M16 ^{1/2} "	8	416590	25.0
		LKS M-114 A	M12/M16 ^{1/2} "	8	416473	26.5
		LKS M-125 A	M12/M16 ^{1/2} "	6	416591	26.5
		LKS M-133 A	M12/M16 ^{1/2} "	6	416474	27.5
	LKS M-139	M12/M16 ^{1/2} "	6	185357	23	
	LKS M-160	M12/M16 ^{1/2} "	6	185366	23	
	LKS M-168	M12/M16 ^{1/2} "	6	185375	23	
	LKS M-219	M12/M16 ^{1/2} "	6	185384	23	
	LKS M-273	M16	2	185393	23	

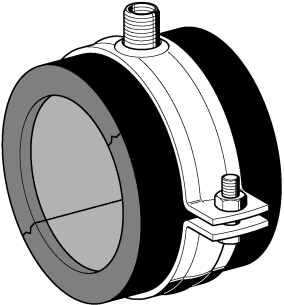

Stran	Produkt	Artikel	Pakirano	Artikel-št.		
2-33	Izolacijska objemka LKS T	Skupina:			Izolacija (cm)	
		LKS T-15	M8/M10	24	110514	31.0
		LKS T-18	M8/M10	24	110515	31.0
		LKS T-22	M8/M10	24	110516	31.0
		LKS T-25	M8/M10	24	110517	31.0
		LKS T-28	M8/M10	24	110518	31.0
		LKS T-30	M8/M10	18	110519	34.0
		LKS T-35	M8/M10	18	110520	34.0
		LKS T-38	M8/M10	18	110521	36.0
		LKS T-42	M8/M10	18	110522	36.0
		LKS T-44	M8/M10	18	110523	37.0
		LKS T-48	M8/M10	18	110524	37.0
		LKS T-54	M8/M10	12	110525	38.0
		LKS T-57	M8/M10	12	110526	38.0
		LKS T-60	M8/M10	12	110527	38.0
		LKS T-64	M8/M10	10	110528	39.0
		LKS T-70	M8/M10	10	110529	39.0
		LKS T-76	M8/M10	8	110530	42.0
		LKS T-80	M8/M10	8	110531	42.0
		LKS T-89	M8/M10	6	110532	42.0
		LKS T-108	M12/M16/1/2"	6	110534	42.0
		LKS T-114	M12/M16/1/2"	6	110535	43.0
		LKS T-133	M12/M16/1/2"	6	110536	44.0
		LKS T-139	M12/M16/1/2"	6	110537	43.0
		LKS T-160	M12/M16/1/2"	4	110538	45.0
		LKS T-168	M12/M16/1/2"	4	110539	45.0
		LKS T-219	M12/M16/1/2"	2	110540	46.0
		LKS T-273	M12/M16/1/2"	2	110541	45.0

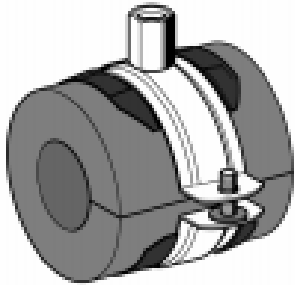
Stran	Produkt	Artikel	Pakirano	Artikel-št.	Izolacija (cm)
2-35	Izolacijska objemka AKS	Skupina:			
		AKS 13-10 M8/M10	50	113429	13.0
		AKS 13-12 M8/M10	50	113430	13.0
		AKS 13-15 M8/M10	50	113431	13.0
		AKS 13-18 M8/M10	50	113432	13.0
		AKS 13-22 M8/M10	50	113433	13.0
		AKS 13-25 M8/M10	50	113434	13.0
		AKS 13-28 M8/M10	50	113435	13.0
		AKS 13-30 M8/M10	50	113436	13.0
		AKS 13-35 M8/M10	50	113437	13.0
		AKS 13-42 M8/M10	30	113438	13.0
		AKS 13-48 M8/M10	30	113439	13.0
		AKS 13-54 M8/M10	30	113440	13.0
		AKS 13-60 M8/M10	30	113441	13.0
		AKS 19-10 M8/M10	50	113446	19.0
		AKS 19-12 M8/M10	50	113447	19.0
		AKS 19-15 M8/M10	50	113448	19.0
		AKS 19-18 M8/M10	50	113449	19.0
		AKS 19-22 M8/M10	50	113450	19.0
		AKS 19-25 M8/M10	50	113451	19.0
		AKS 19-28 M8/M10	50	113452	19.0
		AKS 19-30 M8/M10	50	113453	19.0
		AKS 19-35 M8/M10	40	113454	19.0
		AKS 19-42 M8/M10	30	113455	19.0
		AKS 19-48 M8/M10	30	113456	19.0
		AKS 19-54 M8/M10	30	113457	19.0
		AKS 19-60 M8/M10	20	113458	19.0
		AKS 25-10 M8/M10	25	113463	25.0
		AKS 25-12 M8/M10	25	113464	25.0
		AKS 25-15 M8/M10	25	113465	25.0
		AKS 25-18 M8/M10	25	113466	25.0
		AKS 25-22 M8/M10	25	113467	25.0
		AKS 25-25 M8/M10	30	113468	25.0
		AKS 25-28 M8/M10	30	113469	25.0
		AKS 25-30 M8/M10	30	113470	25.0
		AKS 25-35 M8/M10	30	113471	25.0
		AKS 25-42 M8/M10	20	113472	25.0
		AKS 25-48 M8/M10	20	113473	25.0
		AKS 25-54 M8/M10	20	113474	25.0
		AKS 25-60 M8/M10	20	113475	25.0



Stran	Produkt	Artikel	Pakirano	Artikel-št.	
2-37	Izolacijska objemka KSH / KSM	Skupina: 1254			
		KSH 15	50	180632	
		KSH 17	50	177392	
		KSH 18	50	177401	
		KSH 21	50	177410	
		KSH 22	50	177419	
		KSH 27	50	177428	
		KSH 28	50	177437	
		KSH 33	50	177446	
		KSH 35	50	177455	
		KSH 42	25	177464	
		KSH 48	25	177473	
		KSH 54	25	177482	
		KSH 57	25	177491	
		KSH 60	25	177500	
	2G-Priklop M8/M10	KSM 15	50	180641	
		KSM 17	50	177509	
		KSM 18	50	177518	
		KSM 21	50	177527	
		KSM 22	50	177536	
		KSM 27	50	177545	
		KSM 28	50	177554	
		KSM 33	50	177563	
		KSM 35	50	177572	
		KSM 42	25	177581	
		KSM 48	25	177590	
2-39	Izolacijska objemka SKS	Skupina: 1250			
		17 - 22	$\frac{3}{8}'' - \frac{1}{2}''$	50	191207
		23 - 26		50	194980
		27 - 32	$\frac{3}{4}''$	50	191216
		33 - 38	1"	50	191225
		38 - 42		25	194997
		42 - 47	$1 \frac{1}{4}''$	25	191234
		48 - 54	$1 \frac{1}{2}''$	25	191243
		57 - 62	2"	25	191252
		63 - 68		25	195000
		70 - 75		25	191261
		76 - 81	$2 \frac{1}{2}''$	25	191279
		89 - 94	3"	25	191288
	17 - 172 mm: M16/M10/M8	107 - 112		10	191297
	219 - 327: $\frac{1}{2}''/M16/M12$	113 - 117	4"	10	191306
		125 - 128		10	195048
		133 - 137		10	191315
		138 - 142	5"	10	191324
		157 - 161		10	191333
		168 - 172	6"	10	191342
		219 - 222	8"	1	191351
		272 - 275	10"	1	191369
		324 - 327		1	191378

Stran	Produkt	Artikel	Pakirano	Artikel-št.
2-41	Adapter AD IG/IG	Skupina: 1333		
		M16/M10	50	106740
		M16/M12	50	124665
		M16/M16	50	106290
		$\frac{3}{8}$ "/M16	25	146335
		$\frac{1}{2}$ "/M10	10	146371
		$\frac{1}{2}$ "/M12	25	156639
		$\frac{1}{2}$ "/M16	25	124656
		$\frac{1}{2}$ " $\frac{3}{8}$ "	25	146344
		$\frac{1}{2}$ " $\frac{1}{2}$ "	10	146380
		$\frac{3}{4}$ "/M10	10	105651
		$\frac{3}{4}$ "/M12	10	105749
		$\frac{3}{4}$ "/M16	10	105660
		$\frac{3}{4}$ " $\frac{3}{8}$ "	25	146353
		$\frac{3}{4}$ " $\frac{1}{2}$ "	10	146399
		1"/M10	10	105679
		1"/M12	10	105758
		1"/M16	10	105688
		1" $\frac{3}{8}$ "	25	146362
		1" $\frac{1}{2}$ "	10	146405
		$\frac{3}{8}$ "/M16	20	111715
	$\frac{3}{8}$ " $\frac{1}{2}$ "	20	113349	
2-42	Cevna zanka RSL N	Skupina: 1115		
		33,7 1" M8 (VdS)	100	102287
		42,4 1 $\frac{1}{4}$ " M8 (VdS)	50	102296
		48,3 1 $\frac{1}{2}$ " M8 (VdS)	50	102302
		60,3 2" M8 (VdS)	50	102311
		33,7 1" M10 (FM)	100	102126
		42,4 1 $\frac{1}{4}$ " M10 (FM)	50	102135
		48,3 1 $\frac{1}{2}$ " M10 (FM)	50	102144
		60,3 2" M10 (FM)	50	102153
		76,1 2 $\frac{1}{2}$ " M10	25	102320
		88,9 3" M10	25	102339
		108 M10	25	102348
		114 4" M10	25	102357
		133 M12	25	102366
		139 5" M12	25	102375
		159 M12	25	102384
		168 6" M12	25	102393
		219 8" M16	10	102409

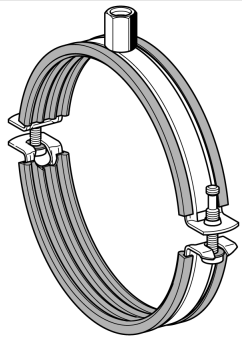
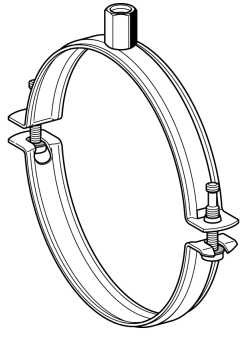

Stran	Produkt	Artikel	Pakirano	Artikel-št.
2-43	Navojno streme RUB	Skupina: 1211		
		1/2" M8	50	102162
		3/4" M8	50	102773
		1" M8	50	102782
		1 1/4" M8	50	102791
		1 1/2" M8	50	102807
		2" M10	50	102816
		2 1/2" M10	50	102825
		3" M10	50	102834
		108 M12	50	102843
		4" M12	25	102171
		133 M12	25	102852
		5" M12	25	102180
		159 M12	25	102861
		6" M12	10	102199
	8" M12	10	102870	
2-44	Enojna PP objemka	Skupina: 1299		
		8 mm	50	124009
		10 mm	50	124018
		12 mm	50	124027
		14 - 15 mm	50	124036
		16 - 18 mm	50	124045
		20 - 22 mm	25	124054
		24 mm	25	124081
		28 mm	25	124090
	35 mm	25	124072	
2-44	Dvojna PP objemka	Skupina: 1299		
		8 mm	50	124106
		10 mm	50	124115
		12 mm	50	124124
		14 - 15 mm	50	124133
		16 - 18 mm	25	124142
		20 - 22 mm	25	124151
		24 mm	25	401998
		28 mm	25	401989

Stran	Produkt	Artikel	Pakirano	Artikel-št.	
3-4		Skupina: 1622			
		71	M8/M10	50	180443
		80	M8/M10	50	180452
		90	M8/M10	50	180461
		100	M8/M10	50	180470
		112	M8/M10	25	180479
		125	M8/M10	25	180488
		140	M8/M10	25	180497
		150	M8/M10	25	180506
		160	M8/M10	25	180515
		180	M8/M10	25	180524
		200	M8/M10	25	180533
		224	M8/M10	10	180542
		250	M8/M10	10	180551
		280	M8/M10	10	180560
		300	M8/M10	10	180569
		315	M8/M10	10	180578
		355	M8/M10	10	180587
		400	M8/M10	10	180596
		450	M8/M10	10	180605
		500	M8/M10	10	180614
3-5		Skupina: 1622			
		71	M8/M10	50	199626
		80	M8/M10	50	199633
		90	M8/M10	50	199640
		100	M8/M10	100	199657
		112	M8/M10	100	199664
		125	M8/M10	100	199671
		140	M8/M10	80	199688
		150	M8/M10	80	199695
		160	M8/M10	80	199701
		180	M8/M10	50	199718
		200	M8/M10	50	199725
		224	M8/M10	50	199732
		250	M8/M10	40	199749
		280	M8/M10	40	199756
		300	M8/M10	40	199763
		315	M8/M10	40	199770
		355	M8/M10	40	199787
		400	M8/M10	30	199794
		450	M8/M10	20	199800
		500	M8/M10	20	199817



Stran	Produkt	Artikel	Pakirano	Artikel-št.
3-7	Prezrač. objemka od DN 560	Skupina: 1602		
		560	1	121848
		600	1	149116
		630	1	121857
		710	1	121866
		800	1	121875
		900	1	121884
		1000	1	121893
		1120	1	121909
		1250	1	121918
3-9	Prezrač. objemka z o. od DN 560	Skupina: 1602		
		560	1	190181
		600	1	190199
		630	1	190208
		710	1	190217
		800	1	190226
		900	1	190235
		1000	1	190244
		1120	1	190253
		1250	1	190262
3-10	Prezrač. objemka Stabil D BSK	Skupina: 1606		
	 	83 / 80	25	413779
		104 / 100	25	413780
		129 / 125	25	413781
		154 / 150	10	413782
		164 / 160	10	413783
		204 / 200	10	413784
		254 / 250	10	413785
		306 / 300	1	413786
		321 / 315	1	413787
		361 / 355	1	413788
		406 / 400	1	413806
		456 / 450	1	413807
		566 / 560	1	413808
		638 / 630	1	413809
		718 / 710	1	413810



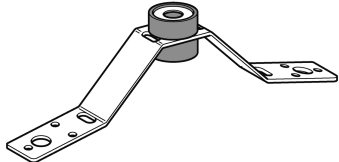
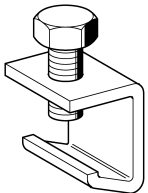
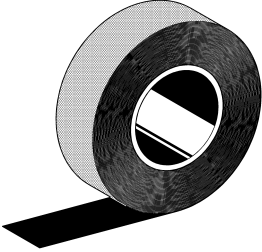
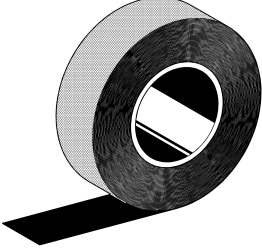

Stran	Produkt	Artikel	Pakirano	Artikel-št.
03-11	Spona za prezrač. cevi LUB Z zvočno izolacijo!	Skupina: 1603 Spona za prezračevanje	100	151582
				
3-11	Kanalna spona LCO	Skupina: 1604 Kanalna spona 20 Kanalna spona 30/40	200 100	170222 413707
				
3-12	Alu trak - BAL	Skupina: 1630 BAL SK 50 mm BAL SK 75 mm	24 16	111691 111692
				
3-13	Izolacijski trak BEB	Skupina: 1630 BEB SK 50 mm BEB SK 75 mm	24 16	111689 111690
				

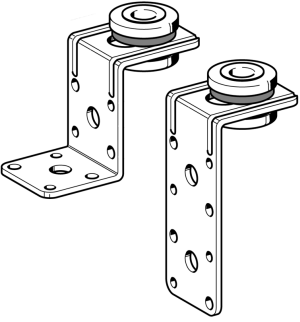
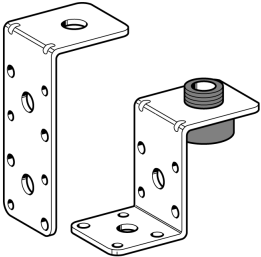
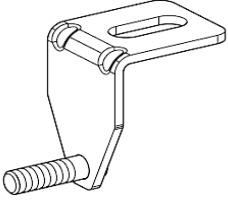
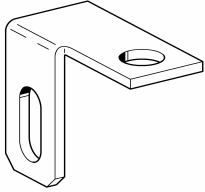
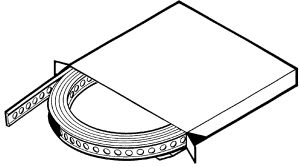
Pritrditev prezračevalnih kanalov

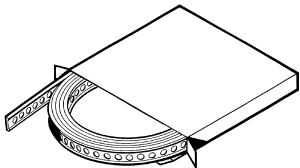
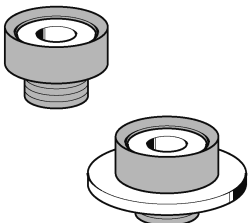
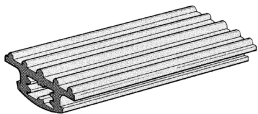
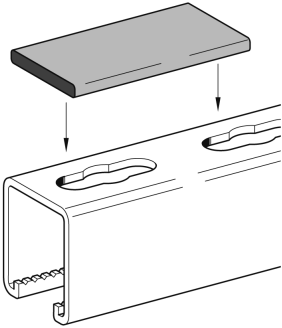

Stran	Produkt	Artikel	Pakirano	Artikel-št.
3-14	Kanalni kotnik LUW 	Skupina: 1601		
		SL	100	189893
		SZ	100	189902
3-15	Kanalni kotnik LUW A 	Skupina: 1621		
		A-L	100	110496
		A-Z	100	110498
		A-SL	100	110497
		A-SZ	100	110499
Stabil 170/90	10	158534		
3-15	Kanalni kotnik LUW F 	Skupina: 1605		
		F M8	100	113331
		SF M8	100	113329
		SF M10	100	113330
3-16	Vezni kotnik FLW 	Skupina: 1601		
		30 levi	100	416902
		30 desni	100	416893
3-16	Perforiran trak BND - cinkan 	Skupina: 1129		
		12 x 0,7 – luknja Ø5.5 mm	10	120892
		17 x 0,7 – luknja Ø6.5 mm	10	120908

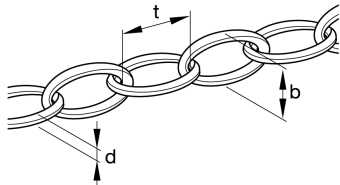

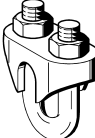
Stran	Produkt	Artikel	Pakirano	Artikel-št.
3-17	Perforiran trak BND	Skupina: 1129 19 - plastificirano	10	121015
				
3-18	Zvočno izolacijski element SDE	Skupina: 2712 / 1610 B 41	100 100	410458 107802
				
3-19	Profilna guma SAL	Skupina: 1611 41 – L22 30m 41/L50	1 Rola 100	101189 101204
				
3-19	Profilna guma SAL SK	Skupina: 1611 SK 40 x 5	10	410341
				

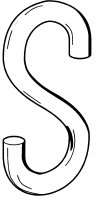
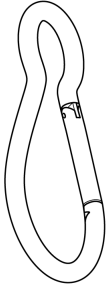

Stran	Produkt	Artikel	Pakirano	Artikel-št.
3-20	Veriga GLK	Skupina: 1345		
		3 x 20 oval	40	402997
				
3-20	Jeklena vrv SDS	Skupina: 1345		
		2 mm	40	415102
		4 mm	40	403762
				
3-21	Zanka za jekleno vrv DSK	Skupina: 1345		
		2 mm	100	415111
		4 mm	100	403744
				
3-21	Klema za jekleno vrv DSL	Skupina: 1345		
		2 mm	100	415120
		4 mm	100	403753
				



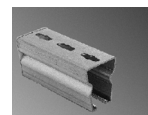

Stran	Produkt	Artikel	Pakirano	Artikel-št.
3-22	Člen za spajanje SGL	Skupina: 1345 4 x 24	100	402043
				
3-22	S-obešalo SHK	Skupina: 1345 6 x 44	100	402070
				
3-23	Karabin KBR	Skupina: 1345 70 x 7 70 x 7 z vijačno zaporo	100 100	400346 400347
				
3-23	Napenjalo SPSL M8	Skupina: 1345 M8	10	400345
				

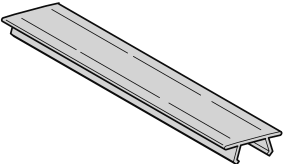
Stran	Produkt	Artikel	Pakirano	Artikel-št.	
4-4	Montažni profili MS	Skupina: 1111			
		41/21/1,5 2	10	173837	
		41/21/1,5 6	6	173846	
		41/21/2,0 2	10	193686	
		41/21/2,0 6	6	193709	
		41/31/2,0 2	10	198872	
		41/31/2,0 6	6	198889	
		41/41/2,0 2	10	193723	
		41/41/2,0 3	3	193730	
		41/41/2,0 6	6	193747	
		41/41/2,5 2	10	173909	
		41/41/2,5 3	3	173432	
		41/41/2,5 6	6	166720	
		41/45/2,5 2	10	193754	
		41/45/2,5 6	6	193761	
		41/52/2,5 2	10	193778	
		41/52/2,5 6	6	193785	
		41/62/2,5 6	6	193792	
		41-75/65/3,0 6	6	173990	
		41-75/75/3,0 6	6	173999	
		41/21/2,0 D * 2	2	193808	
		41/21/2,0 D * 6	6	193815	
		41/41/2,0 D * 6	6	193822	
		41/41/2,5 D * 6	6	166757	
		41/52/2,5 D * 6	6	193846	
		41/62/2,5 D * 6	6	193853	
		41-75/65/3,0 D *6	6	174152	
		41-75/75/3,0 D *6	6	174161	
4-18	Zaključna kapica ADK	Skupina: 1304			
		41/21	100	101037	
		41/31	100	110477	
		41/41	100	177689	
		41/45	100	108812	
		41/52	50	177698	
		41/62	50	153201	
		41-75/65	50	177707	
		41-75/75	50	177716	

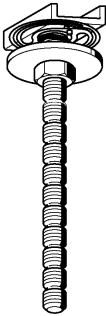
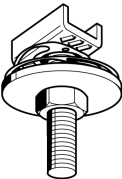

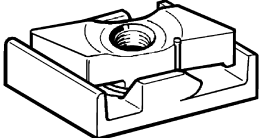
Stran	Produkt	Artikel	Pakirano	Artikel-št.
4-18	Pokrov za profile MSA 41	Skupina: 1304 MSA 41	2	180623
				
4-19	Držalo za kabel KHP	Skupina: E100 KHP	500	110879
				
4-20	Montažni komplet PBS CC 41	Skupina: 1309 M8 x 35 M8 x 75 M8 x 125 M8 x 175 M8 x 275 M10 x 35 M10 x 75 M10 x 125 M10 x 175 M10 x 275	25 25 25 25 25 25 25 25 25 25	191549 191558 191567 191576 191585 191594 191603 191612 191621 191639
				
4-21	Priklop za objemke SAD	Skupina: 1309 M10 x 40 M16 x 35	1 1	602202 602281
				

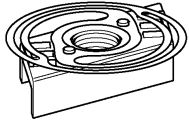
Stran	Produkt	Artikel	Pakirano	Artikel-št.
4-22	Blok PBH 41 	Skupina: 1308		
		M8	50	198988
		M10	50	198995
		M12	50	199008
4-23	Blok PB 41 	Skupina: 1308		
		M8	50	160380
		M10	50	160399
		M12	50	171287
4-24	Priključni kos ASS M16 	Skupina: 1960		
		M16/M10 L	50	161105
4-25	Matica kljukasta NT CC 41 	Skupina: 1314		
		CC 41-M6	50	180200
		CC 41-M8	50	180209
		CC 41-M10	50	180218
		CC 41-M12	50	182252
		CC 41-M16	50	182261

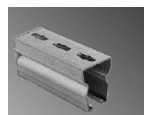

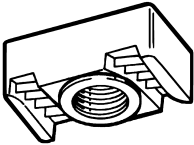
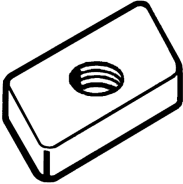
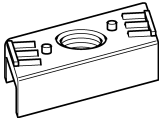
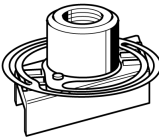

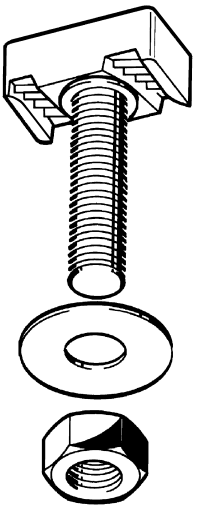
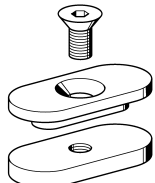
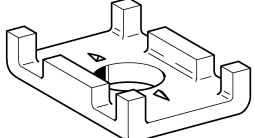
Stran	Produkt	Artikel	Pakirano	Artikel-št.
4-26	Matica kljukasta NT HZ 41	Skupina: 1314		
		HZ 41-M8	50	151935
		HZ 41-M10	50	151944
		HZ 41-M12	50	182288
		HZ 41-M16	50	182297
4-27	Matica navojna NT	Skupina: 1314		
	 	L 41-M8	100	405427
		L 41-M10	100	405436
		L 41-M16	50	405472
		41-M8	50	180173
		41-M10	50	180182
4-28	Adapter NT CC 41 DIN 3015	Skupina: 1314		
		M6	100	110005
		M8	100	110016
		M10	100	110006
		M12	100	110007

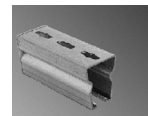

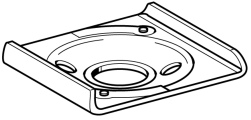
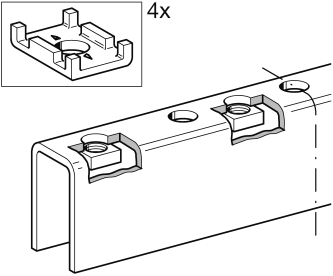
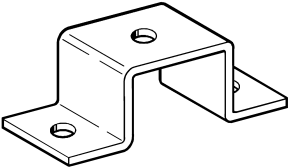
Stran	Produkt	Artikel	Pakirano	Artikel-št.
4-30	Vijak z kljukasto glavo HZ 41 	Skupina: 1311		
		HZ 41 M 8 x 15	50	151953
		HZ 41 M 8 x 20	50	151962
		HZ 41 M 8 x 25	50	151971
		HZ 41 M 8 x 35	50	151980
		HZ 41 M 8 x 55	50	151999
		HZ 41 M 8 x 75	50	152006
		HZ 41 M 8 x 95	50	152015
		HZ 41 M 10 x 15	50	152024
		HZ 41 M 10 x 20	50	152033
		HZ 41 M 10 x 25	50	152042
		HZ 41 M 10 x 35	50	152051
		HZ 41 M 10 x 55	50	152060
		HZ 41 M 10 x 75	50	152079
		HZ 41 M 10 x 95	50	152088
		HZ 41 M 12 x 20	50	152167
		HZ 41 M 12 x 25	50	152176
		HZ 41 M 12 x 35	50	152185
		HZ 41 M 12 x 55	50	152194
		HZ 41 M 12 x 75	50	152200
		HZ 41 M 12 x 95	50	152219
		HZ 41 M 16 x 25	50	152228
		HZ 41 M 16 x 35	50	152237
		HZ 41 M 16 x 55	50	152246
HZ 41 M 16 x 75	50	152255		
HZ 41 M 16 x 95	50	152264		
4-31	Element vezni za profil KL 	Skupina: 1357		
		KL 1	50	118055
4-32	Ozobje kljukasto HK 	Skupina: 1327		
		41/10	50	178247
		41/12	50	178256
		41/16	50	178265

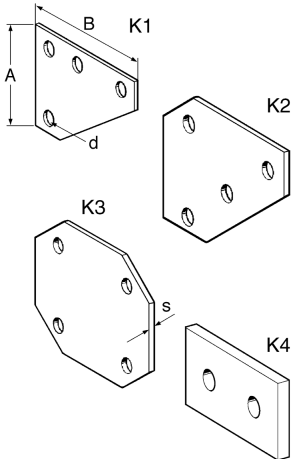
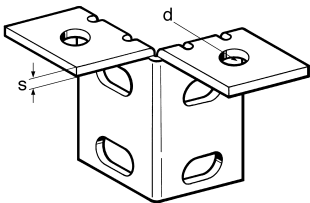

Stran	Produkt	Artikel	Pakirano	Artikel-št.	
4-33	Ozobje kljukasto HK BL	Skupina: 1327			
		BL 8	100	110500	
		BL 10	100	110501	
		BL 12	100	110502	
4-34	Sklop za profile SK	Skupina: 1353			
		SK 41/21-31	10	177599	
		SK 41/41-45	10	155115	
		SK 41/52	10	177608	
		SK 41/62	10	155124	
		SK 41-75/65	10	177617	
		SK 41-75/75	10	177626	
4-35	Držalo profila SH	Skupina: 1112			
		41/21	50	177338	
		41/41 u. 41/21 D	50	177365	
		41/45	50	126791	
		41/52	50	177347	
		41/62	25	177356	
		41-75/65	25	177644	
		41-75/75	25	177662	
		41/41 D	10	177374	
		41/52 D	10	177383	
		41/62 D	10	163000	
		41-75/65 D	10	177671	
		41-75/75 D	10	177680	

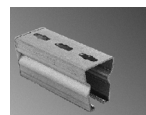
Stran	Produkt	Artikel	Pakirano	Artikel-št.
4-36	Montažni komplet MOS	Skupina: 1330		
		MH 41	10	143800
		MV 41	10	143794
	Tip MV			
4-37	Montažni komplet MOS CC	Skupina: 1330		
		CC - MH 41	10	191756
		CC - MV 41	10	191765
	Tip CC - MH 41			
4-38	Vozliščne plošče KNO	Skupina: 1351		
		KNO 1	10	107769
		KNO 2	10	107778
		KNO 3	10	107787
		KNO 4	100	163347
4-38	Kotni spojnik EV	Skupina: 1352		
		EV 1	10	138024
		EV 2	10	138033

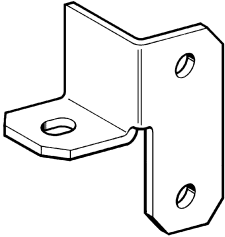
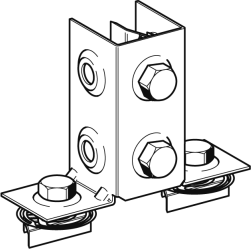
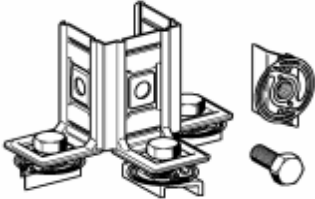

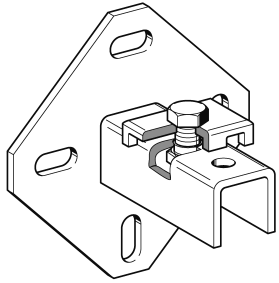
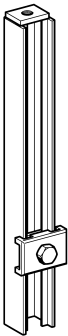
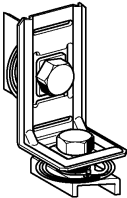

Stran	Produkt	Artikel	Pakirano	Artikel-št.
4-39	Kotni spojnik EW 41	Skupina: 1352 EW 41	25	160803
				
4-40	Spojnik CN CC 41-2	Skupina: 1352 CC 41-2 CC 41-2 W	10 10	193495 193648
				
	Spojnik CN CC 41	Skupina: 1352 CC 41-2-3 CC 41-2-4	10 10	180254 180245
				
	Typ 4			
4-41	Regulator višine HRS P	Skupina: 1339 P M8 P M10	25 25	151519 151528
				

Stran	Produkt	Artikel	Pakirano	Artikel-št.
5-3	WBD držalo 	Skupina: 1356		
		41/21-31	10	177725
		41/41-45	10	155054
		41/52	5	177734
		41/62	5	155063
		41-75/65	5	177743
		41-75/75	5	177752
		41/21 D	5	146469
		41/41-45 D	5	106768
		41/52 D	5	177761
		41/62 D	5	155090
		41-75/65 D	5	177770
		41-75/75 D	5	177779
		5-11	Profilni teleskop ST 41 	Skupina: 1356
ST 41	10			189740
5-12	Kotnik CN CC 41-90° 	Skupina: 1326		
		CC 41-90°	25	180236

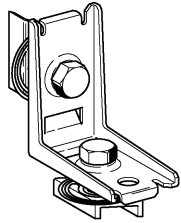
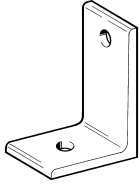
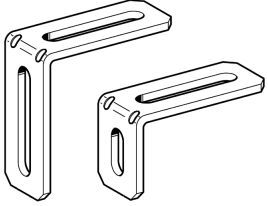

Konzole, osnovne plošče in montažni kotniki

Stran	Produkt	Artikel	Pakirano	Artikel-št.
5-13	Kotnik CN CC 41 Stabil	Skupina: 1326		
		CC 41-90° Stabil	25	191675
		CC 41-90° W Stabil	25	191684
		CC 41-45° Stabil	25	191882
		CC 41-45° W Stabil	25	191891
		CC 41-45° W Stabil BSK	25	409253
5-14	Kotnik MW S	Skupina: 1326		
		45/30/90°	50	115380
		60/40/90°	25	115399
		90/60/90°	25	114820
		55/55/90 BSK	50	415822
5-15	Kotnik MW LL	Skupina: 1326		
		95/55/90°	25	172388
		95/95/90°	25	172397
		95/95/90°	25	114936
		95/50/45°	25	114945
	Kotnik MW			
		90/90/45°	25	106759
		95/95/90°	25	114936

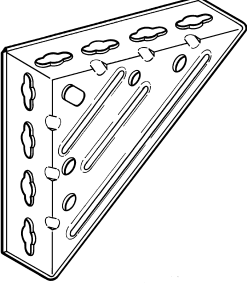
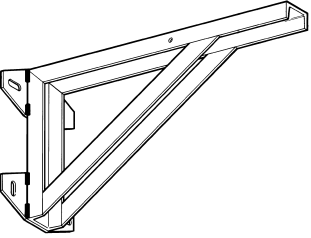
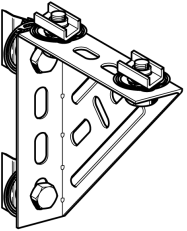
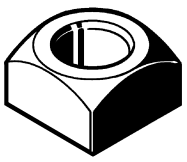
Stran	Produkt	Artikel	Pakirano	Artikel-št.
5-16	Kotna konzola WK  	Skupina: 1326		
		100/100	25	145626
		100/100-40	25	163921
		150/150	25	155513
		200/200	10	118170
		300/200	1	118046
		550/350	1	145635
		725/400	1	151041
		880/550	1	151050
5-23	Kotna konzola WK CC 	Skupina: 1326		
		CC 100/100-40	25	191774
		CC 150/150	10	191783
5-23	Držna matica So-WK 	Skupina: 1327		
		So-WK	25	114848

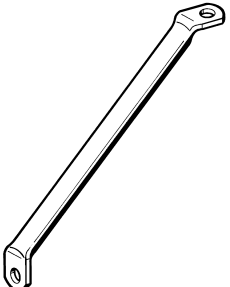
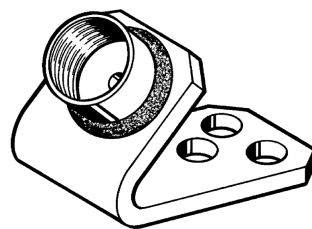
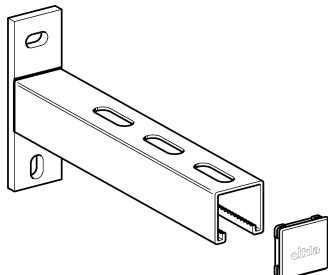

Stran	Produkt	Artikel	Pakirano	Artikel-št.
5-24	Kapica ADK WK Za kotne konzole 300/200 in 550/350 	Skupina: 1304 WK 300 - 550	50	101055
5-24	Opornik STR Primeren tudi za stransko oporo kotne konzole 	Skupina: 1326 300/200 550/350 725/400 880/550	10 10 10 10	125967 125994 151908 151892
5-25	Oporna konzola ST 	Skupina: 1355 $\frac{1}{2}$ " - 45 $\frac{3}{4}$ " - 45 1" - 45 $\frac{1}{2}$ " - 90	25 25 25 25	143828 143837 143846 148744
5-26	Previsna konzola AK 	Skupina: 1354 41/41 - 200 41/41 - 260 41/41 - 320 41/41 - 445 41/41 - 570 41/41 - 820 41/41 - 1010 41/62 - 320 41/62 - 445 41/62 - 570 41/62 - 820 41/62 - 1010	10 10 10 10 10 1 1 10 10 10 1 1	115609 153973 115618 115627 115636 149268 149277 113296 113297 113298 113299 113300

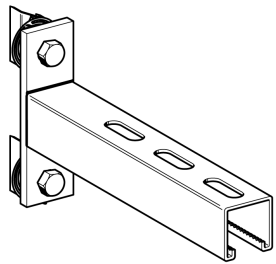
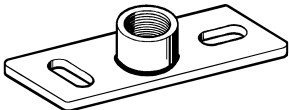
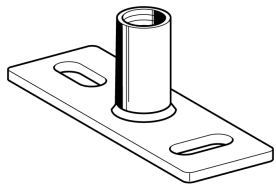
Stran	Produkt	Artikel	Pakirano	Artikel-št.
5-27		Skupina: 1354		
		CC 41/41-200	10	191792
		CC 41/41-260	10	191801
		CC 41/41-320	10	191819
		CC 41/41-445	10	191828
		CC 41/41-570	10	191837
		CC 41/41-820	1	191846
		CC 41/41-1010	1	191855
5-28		Skupina: 1227		
		Normal M8	50	107501
		Normal M10	50	138361
		Normal M16	50	120935
		Normal R 1/2"	50	138501
		Stabil M10	50	138343
		Stabil M12	50	107556
		Stabil M16	50	138352
		Stabil R 1/2"	50	138529
		Stabil R 3/4"	50	138538
		Stabil R 1"	50	107592
		4-Loch 1/2" 80	1	451280
		4-Loch 3/4" 80	1	451281
		4-Loch 1" 80	1	451282
5-29		Skupina: 1227		
		GPL M16	1	666666
		GPL 3/8"	1	666667
		GPL 1/2"	1	666668
		GPL 1/2" močna	1	600952
		GPL 1/2"-D W		666669

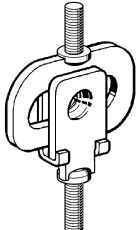
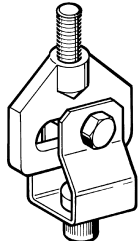
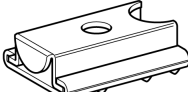
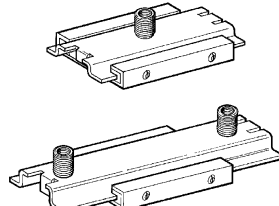

Stran	Produkt	Artikel	Pakirano	Artikel-št.
6-2	Drсни element GLE LC 	Skupina: 1343		
		LC-A 22	100	151069
		LC-I	100	151078
6-3	Drсни element GLE J 	Skupina: 1343		
		J 8	25	126852
		J 10	25	126861
		J 12	25	126870
		J 16	25	126889
6-4	Drsnik GS 1G 	Skupina: 1336		
		1G	25	198834
6-5	Drsnik GS 2G 	Skupina: 1336		
		2G	25	126755
		2G2	25	126764

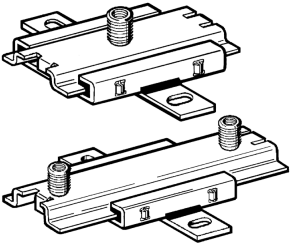
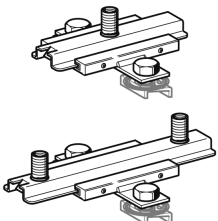
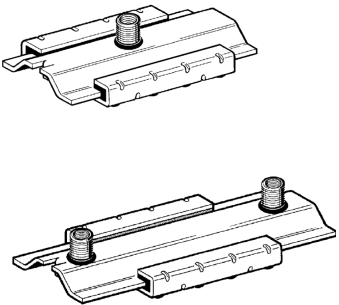
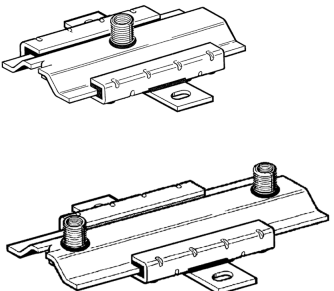

Stran	Produkt	Artikel	Pakirano	Artikel-št.
6-6	Drsnik GS 2G-PL	Skupina: 1336		
		2G-PL	25	127127
		2G2-PL	25	127136
6-7	Drsnik GS CC - 2G-PL	Skupina: 1336		
		CC - 2G-PL	25	191711
		CC - 2G2-PL	25	191729
6-8	Drsnik GS H3G	Skupina: 1336		
		H3G	10	149295
		H3G2	10	126700
6-9	Drsnik GS H3G-PL	Skupina: 1336		
		H3G-PL	10	149301
		H3G2-PL	10	126658

Stran	Produkt	Artikel	Pakirano	Artikel-št.
6-10	Drsnik GS CC - H3G-PL	Skupina: 1336		
		CC - H3G-PL	10	191747
		CC - H3G2-PL	10	191738
6-11	Drsnik GS 41	Skupina: 1336		
		41 - M10	10	190658

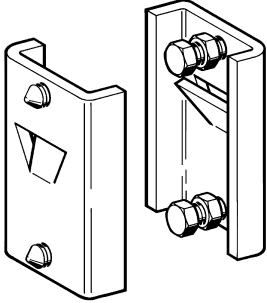
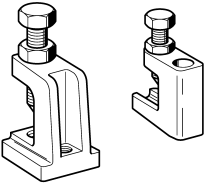
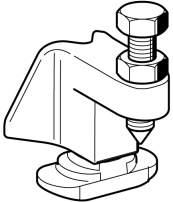
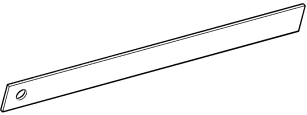

Pritrditev za nosilce in trapezno pločevino

Stran	Produkt	Artikel	Pakirano	Artikel-št.
7-3	Objemna konzola SKL	Skupina: 1350 SKL	5	145671
				
7-4	Spona za nosilec TCS	Skupina: 1337 TCS 0 LC TCS 0 M8/M8 TCS 0 M8/M10 TCS 1 M10/M8 TCS 1 M10/M10 TCS 1 M10/M12 TCS 2 M12/M12 TCS 2 M12/M16	50 50 50 50 50 50 25 25	156648 178283 174206 116770 116150 167332 174224 174215
				
7-5	Spona za nosilec TCS 41	Skupina: 1337 TCS 41	50	110004
				
7-6	Varovalo SL VdS	Skupina: 1338 SL 1 - Ø11 SL 2 - Ø13 SL 3 - Ø17	50 50 50	116798 116804 116813
				

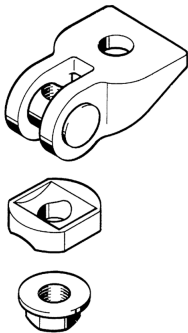
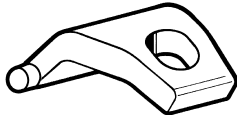
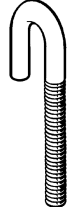
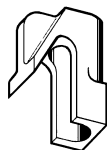

Pritrditev za nosilce in trapezno pločevino

Stran	Produkt	Artikel	Pakirano	Artikel-št.
7-7	Zglob univerzalni UG	Skupina: 1342		
		UG M8	50	198636
		UG M10	50	198643
		UG M12	25	158075
		UG M16	25	158084
		UG FP M12	25	158093
		UG FP M16	25	158109
7-8	Vpenjalni nastavek P	Skupina: 1331		
		P 1 - M8 ali M10	50	116196
		P 2 - M12	25	116202
		P 3 - M16	25	116248
		P 4 - M16	25	116257
7-9	Navojna kljuka GH	Skupina: 1367		
		M8 x 75	100	101587
		M8 x 115	100	101596
		M10 x 150	50	101602
7-10	Vpenjalna kljuka SP	Skupina: 1331		
		SP	50	106777

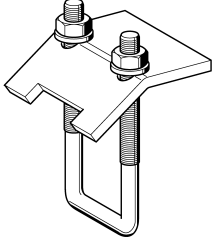
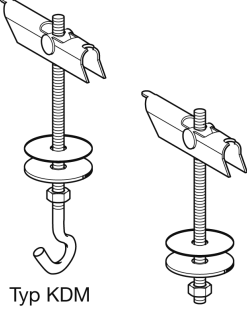
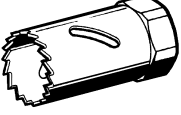
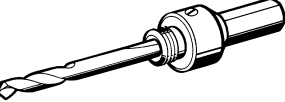

Pritrditev za nosilce in trapezno pločevino

Stran	Produkt	Artikel	Pakirano	Artikel-št.
7-11	Streme vpenjalno SB 41	Skupina: 1331		
		41 - M8	20	192566
		41 - M10	20	183620
		41 D - M10	20	191657
7-12	Previsni vložek KD	Skupina: 1427		
	 <p>Typ KDM</p>	KD M 6 x 130 V	25	402286
		M8 x 100	100	113810
		M8 x 200	50	125569
		TD10 x 100	100	126065
		TD10 x 200	50	125578
7-13	Izrezna žaga LS	Skupina: 8139		
		LS 16	1	402295
		LS 22	1	133144
		LS 25	1	133135
7-14	Nastavek za izrezno žago	Skupina: 8139		
		AS-ZB 1	1	133126



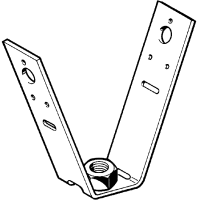
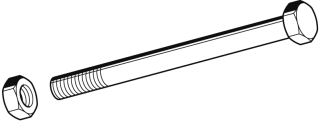
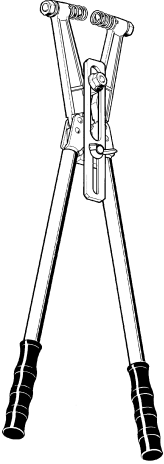

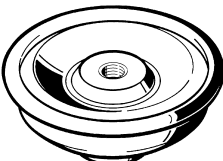

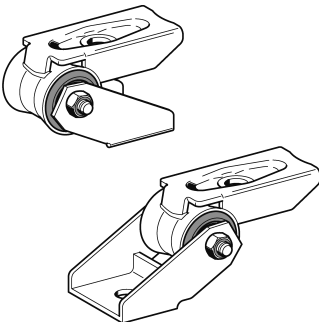
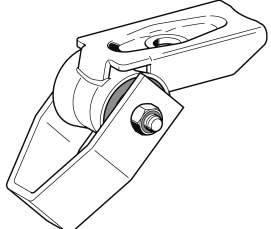
Pritrditev za nosilce in trapezno pločevino

Stran	Produkt	Artikel	Pakirano	Artikel-št.
7-14	Centrirni sveder ZB	Skupina: 8139		
		ZB	1	133117
7-15	Trapezni nosilec TRH	Skupina: 1428		
		M8	100	125693
		M10	100	125806
		RM 8	100	125675
		RM 10	100	125684
		MS	100	151564
7-16	Vijak maticni MSR	Skupina: 1428		
		M8 x 100 z matico	100	406408
7-17	Klešče za luknjanje LOT	Skupina: 8140		
		LOT 3	1	171296

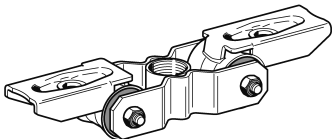
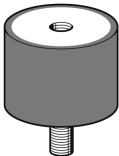
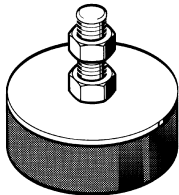
Stran	Produkt	Artikel	Pakirano	Artikel-št.
8-3	Zvočni dušilec SDE 0	Skupina: 1610		
		SDE 0 - M8	100	105068
		SDE 0 - M10	100	105077
		SDE 0 - 0H	100	105059
8-4	Zvočni dušilec SDE 1	Skupina: 1612		
		SDE 1 - M10	25	162735
		SDE 1 - 3G	25	136989
8-5	Ključ za SDE 1	Skupina: 8108		
		Vtični ključ SDE	1	146609
8-6	Zvočni dušilec SDE 2 SBV/SBZ	Skupina: 1612		
		SDE 2 - SBV	10	161406
		SDE 2 - SBZ	10	161062
8-7	Zvočni dušilec SDE 2 - UG 16	Skupina: 1612		
		SDE 2 - UG 16	10	161053



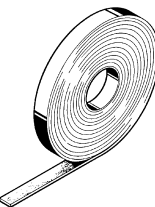
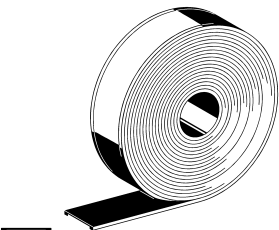
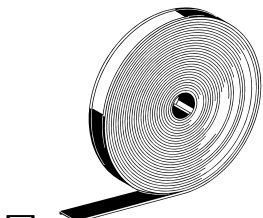

Stran	Produkt	Artikel	Pakirano	Artikel-št.
8-8	Zvočni dušilec SDE 2 - FP 1	Skupina: 1612 SDE 2 - FP 1	10	161071
				
8-9	Akustični element AKE	Skupina: 1399 AKE 41	20	193983
				
8-10	Kovina/guma element GMT	Skupina: 1399 GMT M12 (komplet 4 kos)	1	117090
				
8-11	Profilna guma SAL SBR/EPDM	Skupina: 1294		
		STD 1 25 x 3,0	30	146502
		STD 2 30 x 3,0	30	146511
		STD 3 40 x 4,0	30	146520
		STD 4 50 x 5,0	30	146539
		STD 5 70 x 6,0	30	146548
8-12	Profilna guma SAL silikon	Skupina: 1292		
		STD 1 SIL 25 x 3,0	30	145644
		STD 2 SIL 30 x 3,0	30	145653
		STD 3 SIL 40 x 4,0	30	145662
		STD 4 SIL 50 x 5,0	30	146557

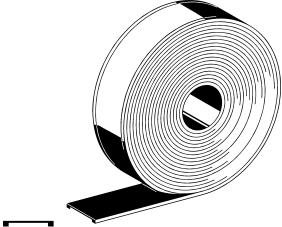

Stran	Produkt	Artikel	Pakirano	Artikel-št.
8-13	Samolepilna guma MSK 	Skupina: 1293		
		20 x 3,0	150	137616
		20 x 4,0	150	137412
		25 x 3,0	120	137722
		25 x 4,0	120	136563
		30 x 3,0	100	137607
		30 x 4,0	100	401728
		40 x 4,0	70	401729
8-13	Trak iz steklenih vlaken GSK 	Skupina: 1291		
		25 x 2	120	193037
		30 x 2	100	193044
		40 x 2	70	193051
		50 x 2	60	193068
		60 x 2	50	193075
		70 x 2	40	193082
8-14	PE vložni trak 	Skupina: 7989		
		PE 20 x 1,5	100	136642
8-14	Vložni trak - umetna masa EKS 	Skupina: 7988		
		30 x 1,5	100	108690
		40 x 1,5	100	401746

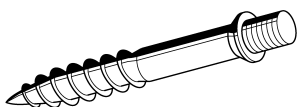



Stran	Produkt	Artikel	Pakirano	Artikel-št.
8-14	Trak za profil SAL EPDM sk	Skupina: 1294		
		30 x 1,0	20	188075
		40 x 1,0	20	188084
		50 x 1,0	20	188093
		60 x 1,0	20	188102
		70 x 1,0	20	188111

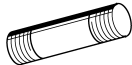
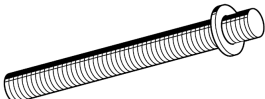

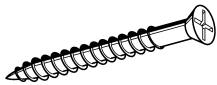

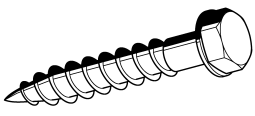
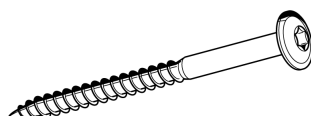
Stran	Produkt	Artikel	Pakirano	Artikel-št.
9-8	Hanger vijak BSCR z vezjo Lesni navoj 6 mm	Skupina: 1315		
		M6 - H6/30/50	100	410647
		M8 - H8/30/50	100	138219
				
9-8	Hanger vijak BSCR brez vezi	Skupina: 1315		
		M8/60 mm	100	160849
		M8/90 mm	100	404491
		M8/120 mm	100	124595
		M8/140 mm	50	124629
		M8/160 mm	50	124601
		M8/180 mm	50	404374
		M10/60 mm	100	153469
		M10/80 mm	100	124452
		M10/100 mm	100	129554
		M10/120 mm	50	124461
		M10/140 mm	50	124470
		M10/180 mm	50	131522
				
9-8	Nastavek za hanger vijake	Skupina: 8101		
		M8	1	121343
		M10	1	121334
				
9-9	Plošča za dvojno držalo M8	Skupina: 1329		
		65 mm	50	124850
		85 mm	50	124869
		105 mm	50	124878
		125 mm	50	411772
				

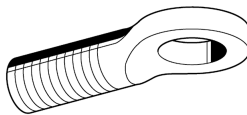

Stran	Produkt	Artikel	Pakirano	Artikel-št.
9-9	Stebelni vijak BOL M8	Skupina: 1318 12 mm	100	124586
				
9-9	Dvojni navojni spojnik DOP	Skupina: 1318 M8/25 mm M8/40 mm M8/70 mm	100 100 100	137768 137704 405346
				
9-10	Li-Ko vijaki LK	Skupina: 1376 4 x 30 4 x 40 4 x 50 5 x 40 5 x 50 5 x 60 5 x 70 6 x 50 6 x 60 6 x 70 6 x 80	200 200 200 200 200 200 200 200 200 100 100	406417 404554 404563 406426 404572 404581 406435 404590 404599 404608 406444
				
9-10	Spax vijaki SNK TG	Skupina: 1376 4 x 40 4 x 50 5 x 50 5 x 60 5 x 70 6 x 50 6 x 60 6 x 70	500 500 200 200 200 200 200 200	410863 410872 410881 410890 410899 410908 410917 410926
				

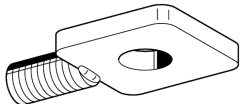
Stran	Produkt	Artikel	Pakirano	Artikel-št.	
9-11	Šestrobi lesni vijak SKH	Skupina: 1370			
		6/50 mm	200	405382	
		6/60 mm	200	405355	
		6/70 mm	100	166997	
		6/80 mm	100	405373	
		8/50	100	156596	
		8/60	100	156602	
		8/70 mm	100	167013	
		8/80	100	156611	
		8/100 mm	100	125107	
		8/120 mm	100	405409	
		10/70	100	156620	
		10/80 mm	100	405391	
		10/100	100	153663	
		10/120 mm	100	405400	
9-11		Lesni vijak	Skupina: 1369		
			8/40	50	110804
	8/60		50	110805	
	8/80		50	110806	
	10/70		50	110807	
	10/100		50	110809	
9-12	Ušesni vijak SCR LL	Skupina: 1302			
		6 mm x 50	100	124249	
		8 mm x 50	100	124258	
9-12	Očesni vijak SCR	Skupina: 1303			
		M8 x 20	100	102418	
		M10 x 20	100	102427	

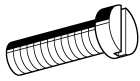

Stran	Produkt	Artikel	Pakirano	Artikel-št.
9-13	Ploščični vijak SCR	Skupina: 1303		
		M8 x 20	100	102436
		M8 x 40	100	102445
		M10 x 20	100	102454
		M10 x 40	50	102463
		M12 x 40	50	102764
		M16 x 25	25	101824
9-13	Cevno vpenjalo SCB	Skupina: 1301		
		M8 - Ø11	100	124221
		M10 - Ø12	100	124203
		M12 - Ø13	100	150916
9-14	Vijak z zarezo SCR	Skupina: 1370		
		M5 / 16	200	125204
		M5 / 20	200	125213
		M6 / 20	200	125240
9-14	Vijak z vrtalno konjico SKB	Skupina: 1370		
		4,2 x 13	1000	413140
		4,2 x 19	1000	413158
		4,2 x 25	1000	413159
		6,3 x 25	500	413149

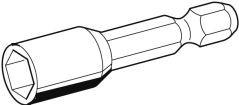

Stran	Produkt	Artikel	Pakirano	Artikel-št.
9-15	Samorezni vijak SCR L	Skupina: 1370		
		SCR L-14	1000	110577
		SCR L-18	1000	110877
9-15	Magnetni nastavek MN	Skupina: 8101		
		SW 7	1	412960
		SW 10	1	412969
		SW 13	1	412978



Stran	Produkt	Artikel	Pakirano	Artikel-št.
9-16	Šestrobi vijak SKT	Skupina: 1370		
		M8/16	100	125161
		M8/20	100	138459
		M8/25	100	138431
		M8/30	100	138574
		M8/35	100	404788
		M8/40	100	138440
		M8/60	100	114705
		M8/70	100	406462
		M8/80	100	114714
		M8/100	100	138608
		M8/110	100	124975
		M10/16	100	406480
		M10/20	100	138617
		M10/25	100	138468
		M10/30	100	138626
		M10/35	100	404815
		M10/40	100	114158
		M10/45	100	406489
		M10/60	100	138635
		M10/70	100	406498
		M10/80	50	114723
		M10/100	50	114732
		M10/120	50	138644
		M12/16	100	406661
		M12/20	100	138653
		M12/25	100	138662
		M12/30	100	138477
		M12/35	100	404419
		M12/40	50	138671
		M12/45	100	406516
	M12/55	100	413167	
	M12/60	50	138680	
	M12/70	50	405328	
	M12/80	50	138705	
	M12/100	50	138714	
	M12/120	50	114750	
	M16/25	50	138723	
	M16/30	50	138732	
	M16/35	50	404428	
	M16/40	50	406552	
	M16/45	50	138741	
	M16/50	50	404446	
	M16/60	50	138556	
	M16/80	25	138750	
	M16/100	25	138769	
	M16/120	25	114778	
	M20/60	25	406561	
	M24/70	25	404482	

Stran	Produkt	Artikel	Pakirano	Artikel-št.	
9-18	Podložka US	Skupina: 1372			
		5/125	100	125301	
		6/125	100	125310	
		8/125	100	125329	
		10/125	100	137564	
		12/125	100	114246	
		16/125	100	114255	
		8/9021	100	137883	
		8/9022	200	404716	
		8/40	100	105581	
		8/45	100	105624	
		10/9021	100	125365	
		10/40	100	105590	
		10/45	100	105633	
		12/30	100	156462	
		12/40	100	105606	
		16/40	100	105615	
		16/9021	100	406570	
9-18		Matica NT	Skupina: 1371		
			M5	100	125338
			M6	100	125347
	M8		100	125356	
	M10		100	137546	
	M12		100	114228	
	M16		100	114237	
	M20		50	404383	
	M24		50	404392	
9-19	Matica prirobna NT FLA	Skupina: 1374			
		M8	50	158729	
		M10	25	158738	
		M12	25	158747	
		M16	10	160654	

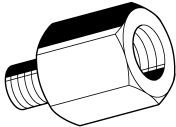

Stran	Produkt	Artikel	Pakirano	Artikel-št.
9-19	Matica narebričena N	Skupina: 1116		
		M8	100	102232
		M10 FM	50	102241
		M10	25	102250
		M12	50	102269
		M16	25	102278
9-20	Podaljšek navojni AD IG/IG	Skupina: 1332		
		M8 x 25	100	124920
		M10 x 30	100	124939
		M12 x 35	50	124948
		M16 x 40	50	124957
9-20	Podaljšek okrogli AD RD	Skupina: 1332		
		M8 x 30	100	157232
		M10 x 30	100	157250
		M12 x 35	50	157278
		M16 x 45	50	157296
		M16 x 100	20	191108
		M16 x 150	20	191117
		1/2" x 45	20	191126
		1/2" x 100	20	191135
		1/2" x 150	20	191144
9-21	Prehodni kos AD IG/AG	Skupina: 1313		
		8/10	50	113670
		10/8	50	113689
		10/16	50	113698
		16/10	50	113704

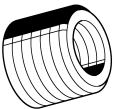
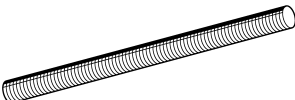
Stran	Produkt	Artikel	Pakirano	Artikel-št.
9-21	Navojna reducirka AD AG/IG	Skupina: 1319		
		16/10	25	124230
		16/12	25	124267
9-22	Navojni zatič GST	Skupina: 1316		
		M8/25	100	124513
		M8/40	100	126913
		M8/70	100	126922
		M8/100	100	111580
		M8/125	50	111669
		M8/150	50	111599
		M8/175	50	111678
		M8/200	50	111605
		M8/225	25	111687
		M8/250	25	111614
		M10/25	100	126940
		M10/40	100	126959
		M10/70	100	126968
		M10/100	100	111623
		M10/125	50	111696
		M10/150	50	111632
		M10/175	50	111702
		M10/200	50	111641
		M10/225	25	111711
		M10/250	25	111650
		M12/100	50	111429
		M12/125	50	111766
		M12/150	50	111438
		M12/175	25	111775
		M12/200	25	111447
		M12/225	25	111784
		M12/250	25	111456
		M16/70	50	405454
	M16/100	50	111465	
	M16/125	50	111793	
	M16/150	50	111474	
	M16/200	25	111483	
	M16/250	25	111492	

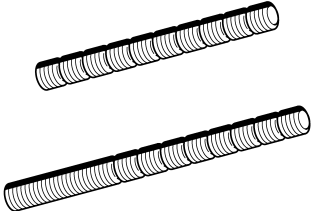
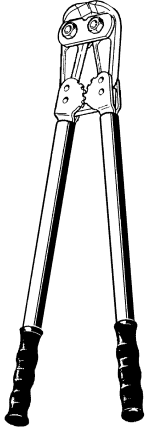
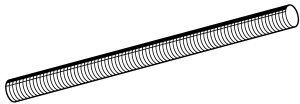

Stran	Produkt	Artikel	Pakirano	Artikel-št.
9-24	Navojni zatič PNS	Skupina: 2109		
		M8 x 90	100	160308
		M8 x 140	100	160317
		M8 x 190	100	160326
		M8 x 290	100	160335
		M8 x 1000	1	157755
		M10 x 90	100	160344
		M10 x 140	100	160353
		M10 x 190	100	160362
		M10 x 290	100	160371
		M10 x 1000	1	157773
9-25		Klešče za PNS navojni zatič	Skupina: 2107	
		PBC	1	155683
9-26		Navojna palica GST 4.6	Skupina: 1317	
		M8 x 1000	25	124559
		M10 x 1000	25	124568
		M12 x 1000	25	143192
		M16 x 1000	10	110817
		M8 x 3000	30	142739
		M10 x 3000	30	142748
		M12 x 3000	30	142757
		M16 x 3000	15	142766

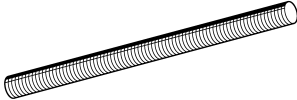
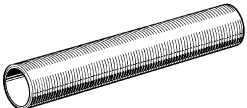
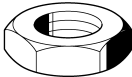
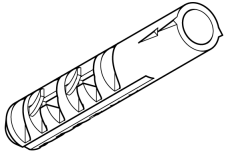
Stran	Produkt	Artikel	Pakirano	Artikel-št.
9-26	Navojna palica BSK 5.8	Skupina: 1317		
		M10 x 3000	3	415813
		M12 x 3000	3	415814
		M16 x 3000	3	415815
				
9-27	Navojna cev GR	Skupina: 1310		
	Dolžina: 2 m	G 1/2"	2	151102
		G 3/4"	2	151111
		G 1"	2	151120
				
9-27	Protimatica NT G	Skupina: 1310		
		G 1/2"	25	157092
		G 3/4"	25	157108
		G 1"	25	157117
				
9-28	Plastični vložek ANN	Skupina: 1411		
		ANN 5 x 25	100	402100
		ANN 6 x 30	100	402101
		ANN 8 x 40	100	402102
		ANN 10 x 50	50	402103
		ANN 12 x 60	25	402104
		ANN 14 x 75	20	402105
				

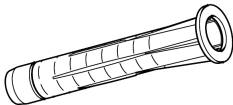
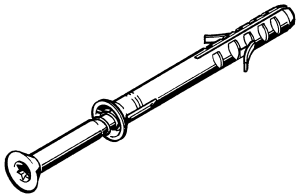
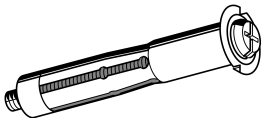

Stran	Produkt	Artikel	Pakirano	Artikel-št.	
9-29	Univerzačni vložek ANU	Skupina: 1415			
		ANU 6 x 34	100	402200	
		ANU 8 x 47	100	402201	
		ANU 10 x 57	50	402202	
		ANU 12 x 68	25	402203	
		ANU 14 x 73	20	402204	
9-30	Vložek z žbljem ANH	Skupina: 1418			
		5 x 35	100	402380	
		5 x 45	100	402381	
		6 x 35	100	402382	
		6 x 60	100	402383	
		6 x 70	100	402384	
		8 x 60	100	402385	
		8 x 80	100	402386	
		8 x 100	100	402387	
		8 x 120	100	402388	
9-31	Vložek za votle stene ANC-M	Skupina: 1416		(debelina stene)	
		M4/12	100	402400	3 - 12
		M5/16	100	402401	3 - 16
		M5/32	100	402402	11 - 32
		M6/16	100	402403	3 - 16
		M6/32	100	402404	11 - 32
		M8/21	100	402405	5 - 21
		M8/34	100	402406	16 - 34

Stran	Produkt	Artikel	Pakirano	Artikel-št.
9-31	Montažne klešče za ANC-M	Skupina: 1416 M4 - M8	1	408578
9-32	Vložek iz medenine ANM	Skupina: 1403 M8 M10 M12 M16	100 100 50 25	402420 402421 402422 402423
9-33	Masa za sidranje VM-K	Skupina: 1409 VM-K 345 Mešalna cev ANT VM-X	1 1	110452 190829
9-35	Masa za sidranje VMU	Skupina: 1409 VMU 300 VMU 345 Mešalna cev ANT VM-X	1 1 1	110562 110474 190829

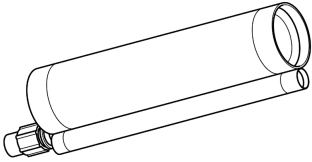
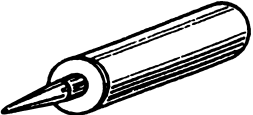
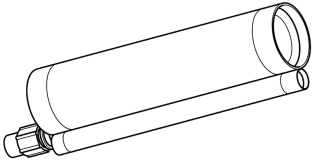
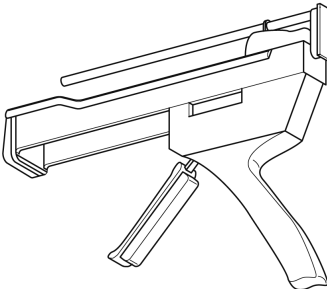

Stran	Produkt	Artikel	Pakirano	Artikel-št.
9-38	Masa za sidranje VMU express	Skupina: 1409 Kartuša 280 ml	1	110563
				
9-39	Masa za sidranje MIT-Cool	Skupina: 1417 Kartuša 300 ml	1	407283
				
9-40	Masa za sidranje VMZ	Skupina: 1409 VMZ 345 Mešalna cev ANT VM-X	1 1	190811 190829
				
9-41	Pribor VMZ / VMU / VM-K	Skupina: 8106 Iztisna pištola ANT VM-P 345 P Jeklana krtača VMZ-STB M8 Jeklana krtača VMZ-STB M10 Jeklana krtača VMZ-STB M12 Jeklana krtača VMZ-STB M16 Izpihovalna tlačilka ANT VM-AP	1 1 1 1 1 1	190874 190838 190847 190856 190865 190883
				

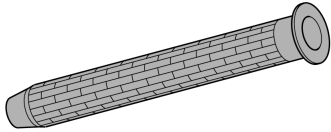
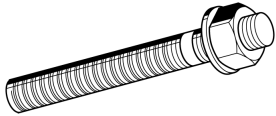
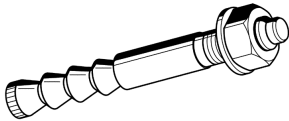
Stran	Produkt	Artikel	Pakirano	Artikel-št.
9-42	Vložek SH	Skupina: 1410		
		VMU-SH M8	10	110504
		VMU-SH M10	10	110505
		VM-SH 12 x 1000	50	110564
		VM-SH 16 x 1000	50	110565
		VM-SH 22 x 1000	25	110566
9-43	Sidni vijak VMU-A	Skupina: 1409		
		VMU-A 8-20/110	10	110444
		VMU-A 8-55/145	10	110445
		VMU-A 10-30/130	10	110447
		VMU-A 10-50/150	10	110448
		VMU-A 12-15/120	10	110449
		VMU-A 12-50/155	10	110450
		VMU-A 16-15/160	10	110451
9-44	Sidni vijak VMZ-A	Skupina: 1409		
		VMZ-A M8-15/80	10	190712
		VMZ-A M8-30/95	10	190721
		VMZ-A M10-10/85	10	190739
		VMZ-A M10-30/105	10	190748
		VMZ-A M10-60/135	10	190757
		VMZ-A M12-10/110	10	190766
		VMZ-A M12-25/125	10	190775
		VMZ-A M12-50/150	10	190784
		VMZ-A M16-30/180	10	190793
		VMZ-A M16-60/210	10	190802



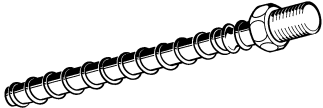
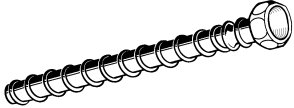
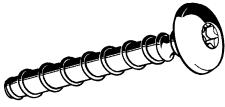

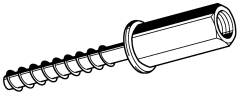
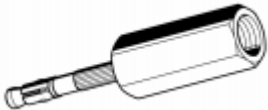
Stran	Produkt	Artikel	Pakirano	Artikel-št.
9-46	Vijačno sidro MMS-ST	Skupina: 1402		
		7,5 x 70	100	157816
		7,5 x 80	100	157825
		7,5 x 100	100	157834
		7,5 x 120	100	157843
		7,5 x 140	50	157852
		7,5 x 160	50	157861
		10 x 80	50	157889
		10 x 100	100	157898
		10 x 120	50	157904
9-48		Vijačno sidro MMS-S	Skupina: 1407	
		7,5 x 45	100	158570
		7,5 x 50	100	158589
		7,5 x 60	100	158598
		7,5 x 80	50	158604
		7,5 x 100	50	158613
		7,5 x 120	50	158622
		7,5 x 140	50	158631
		10 x 60	50	158659
		10 x 80	50	158677
		10 x 100	50	158686
		10 x 120	25	158695
		10 x 140	25	158701
		10 x 160	25	158710
9-50		Vijačno sidro MMS-PR	Skupina: 1405	
		MMS-PR 7,5 x 50	100	157959
		MMS-PR 7,5 x 60	50	411691

Stran	Produkt	Artikel	Pakirano	Artikel-št.
9-51	Nastavek BIT Torx 30	Skupina: 8107 Torx 30	1	403447
				
9-52	Vijačno sidro MMS-I M8/M10	Skupina: 1402 7,5 x 60	40	412717
				
	Sidro AN	Skupina: 1406 AN N6 M8/M10	100	112152
				

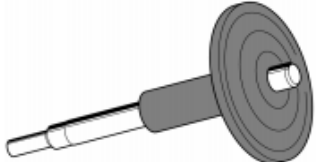
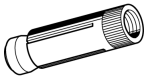
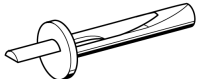

Stran	Produkt	Artikel	Pakirano	Artikel-št.
9-54	Sidro AN BZ plus	Skupina: 1408		
		8/6/60 s *	100	114134
		8/10/21/75 *	100	114135
		8/30/41/95 *	100	114136
		8/50/61/115 *	100	114137
		8/100/111/165 *	50	114138
		10/10/70 s	50	114139
		10/10/30/90	50	114140
		10/20/40/100	50	114141
		10/30/50/110	50	114142
		10/50/70/130	50	114143
		10/75/95/155	50	114144
		10/100/120/180	50	114145
		12/10/85 s *	25	114146
		12/15/35/110	25	114147
		12/30/50/125	25	114148
		12/50/70/145	25	114149
		12/65/85/160	25	114150
		12/85/105/180	25	114151
		12/105/125/200	25	114152
		12/160/255	20	114153
		16/5/105 s *	20	114154
		16/25/45/145	20	114155
		16/50/70/170	20	114156
	16/100/220	10	114157	
9-56	Udarno sidro AN	Skupina: 1401		
		M8 x 30	100	125505
		M8 x 40	100	153283
		M10 x 40	50	125514
		M12 x 50	50	125523
		M16 x 65	25	112518
9-58	Udarno sidro AN ES	Skupina: 1401		
		ES M8 x 30	100	110467
		ES M8 x 40	100	110468
		ES M10 x 30	50	110506
		ES M10 x 40	50	110469
		ES M12 x 50	50	110470

Stran	Produkt	Artikel	Pakirano	Artikel-št.
9-60		Skupina: 8103		
		M8 x 30	1	132790
		M8 x 40	1	153308
		M10 x 30	1	110567
		M10 x 40	1	132806
		M12 x 50	1	132815
		M16 x 65	1	116992
		Skupina: 8103		
		M8 x 30	1	111834
		M8 x 40	1	111835
		M10 x 30	1	111836
		M10 x 40	1	111837
		M12 x 50	1	111838
		M16 x 65	1	111839
9-61		Skupina: 1412		
		AN M8	50	110463
		AN M10	50	110465
		AN M12	25	110466
9-63		Skupina: 1406		
		PN 27 N6 x 35	100	196298
9-64		Skupina: 8103		
		Sornik za profilni žebelj PN	1	196595

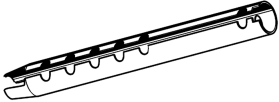
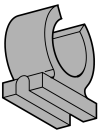
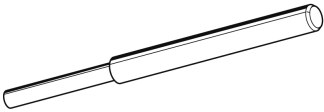

Stran	Produkt	Artikel	Pakirano	Artikel-št.
9-64	Vložek sadaro - SDK	Skupina: 1510		
		D 12 L	100	126241
		D 16 L	100	126232
		D 20 L	100	126214
		D 24 L	100	126205
9-65	Zvočna zaščita za Sadaro vložek SDK	Skupina: 1509		
		Zvočna zaščita	100	126287
9-65	Udarni sornik za SDK Sadaro	Skupina: 8101		
		Udarni sornik	1	114398

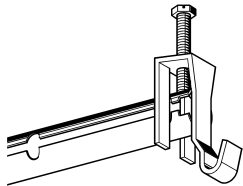
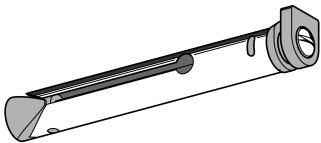
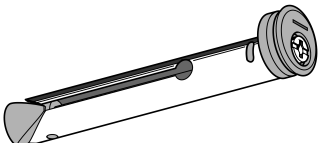
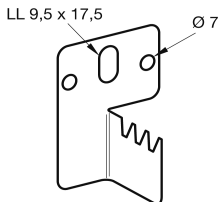
Stran	Produkt	Artikel	Pakirano	Artikel-št.
9-65	Regulator višine SDK	Skupina: 1504 Refulator višine	100	126250
				
9-66	Vijačna konzola RA	Skupina: 1514 100 RA 130 RA 160 RA 200 RA 240 RA	100 100 100 100 50	406039 126524 126533 126542 406048
				
9-66	Vijačna konzola PLE	Skupina: 1520 100 PLE 130 PLE 160 PLE 200 PLE 240 PLE	100 100 100 100 100	126506 126588 126597 126603 137458
				
9-67	Kotna konzola WK z izolacijo	Skupina: 1519 Konzola z zvočno izolacijo	100	114431
				

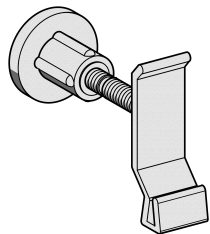
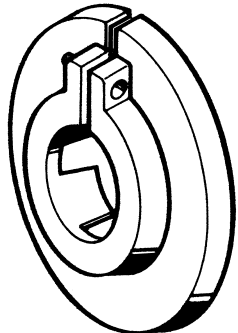
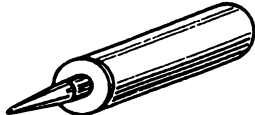
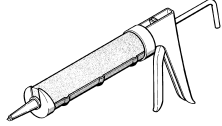

Stran	Produkt	Artikel	Pakirano	Artikel-št.
9-67	Distančnik za grelna telesa	Skupina: 1503		
		K	100	126649
		L	100	126667
9-68	Rozeta HKR	Skupina: 7303		
		RK 12	50	406057
		RK 15	50	406066
		RK 18	50	406075
		RK 22	50	406084
		RK 28	50	406093
		RK 35	50	406102
9-69	Silikonski kit SIK	Skupina: 7401		
		beli	20	135863
		prozoren	20	139733
9-69	Pištola za kit APP	Skupina: 7402		
		Standard	1	133737
		Profi	1	408596

Stran	Produkt	Artikel	Pakirano	Artikel-št.
9-70	WC - Pritrditev WCB	Skupina: 1551		
		WC 1 6/70 - beli	50	406111
		WC 1 6/70 - cromiran	50	127321
9-70	WT - Pritrditev WTB	Skupina: 1550		
		120 ST/S 14	60	127376
		140 ST/S 14	60	127367
		180 ST/S 14	25	143235



Stran	Produkt	Artikel	Pakirano	Artikel-št.
10-2	Set fiksne točke FPK	Skupina: 1380		
		FP-K3/1	1	407876
		FP-K4/1	1	407885
		FP-K5/1	1	407894
		FP-K3/2	1	407903
		FP-K4/2	1	407912
		FP-K5/2	1	407921
10-3	Fiksna točka - vozliščna plošča	Skupina: 1381		
		FP-K3/16	10	404140
		FP-K4/16	10	404158
		FP-K5/16	5	406976
10-3	Fiksna točka - ravna plošča	Skupina: 1381		
		FP-FL-ST/3	10	404167
		FP-FL-ST/4	10	406381
		FP-FL-ST/5	10	406985



Stran	Produkt	Artikel	Pakirano	Artikel-št.
10-4	Objemka fiksne točke FS	Skupina: 1380		
		21,3	1	159979
		26,9	1	159988
		33,7	1	159997
		42,4	1	160007
		45	1	160016
		48,3	1	160025
		57	1	160034
		60,3	1	160043
		76,1	1	160052
		88,9	1	160061
		108	1	160070
		114	1	160089
		133	1	160098
		139	1	160104
		159	1	160113
		168	1	160122
		219	1	160131
		274	1	160140
		324	1	160159
		356	1	160168
	368	1	160177	
	407	1	160186	
	419	1	160195	
	508	1	160201	
	521	1	160210	
10-6	Izolacijska fiksna točka FKS	Skupina: 1382		
		76,1	1	190271
		88,9	1	190289
		108	1	190298
		114,3	1	190307
		133	1	190316
		139,7	1	190325
		159	1	190334
		168,3	1	190343
		219,1	1	190352
		273	1	190379
		323,9	1	190388
10-7		Tesnilna masa DP 30/45	Skupina: 1252	
		30/45	1	146283

Stran	Produkt	Artikel	Pakirano	Artikel-št.
10-8	Povezovalni sklop VP A/B	Skupina: 1380		
		A/B-M12	1	160663
		A/B-M16	1	160672
		A/B- $\frac{1}{2}$ "	1	160681
		A/B- $\frac{3}{4}$ "	1	160690
		A/B-1"	1	160706
10-9	Povezovalni sklop VP SDE 2	Skupina: 1380		
		SDE 2 A/B-M16	1	178166
		SDE 2 A/B- $\frac{1}{2}$ "	1	178175
		SDE 2 A/B- $\frac{3}{4}$ "	1	178184
		SDE 2 A/B-1"	1	178193

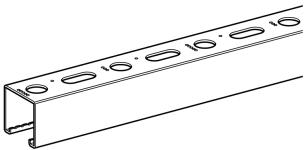
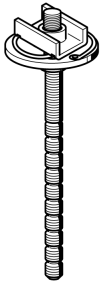
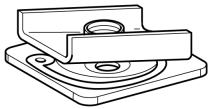
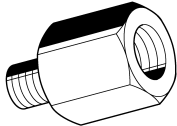

Stran	Produkt	Artikel	Pakirano	Artikel-št.
11-3,5	Montažni profil MS 27 – 1,25	Skupina: 2711		
		27/15/1,25 2	20	110856
		27/25/1,25 2	20	110857
		27/25/1,25 6	36	110858
		27/37/1,25 2	20	110569
		27/37/1,25 6	24	110570
11-7	Blok set PBS CC 27	Skupina: 2761		
		M8 x 35	100	195888
		M8 x 75	100	195895
		M8 x 125	50	195901
		M8 x 175	50	195918
		M8 x 275	50	195925
11-8	Blok PB 27	Skupina: 2760		
		M8	100	195932
11-8	Prehodni kos AD IG/AG	Skupina: 1313		
		10/8	50	113689

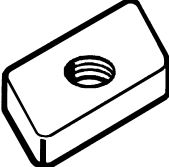
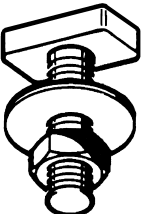
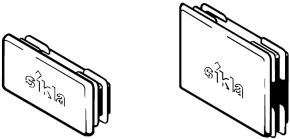

Stran	Produkt	Artikel	Pakirano	Artikel-št.
11-9	Matica kljukasta NT CC 27	Skupina: 2714		
		CC 27-M6	100	195956
		CC 27-M8	100	195949
11-9	Matica navojna NT 27	Skupina: 2714		
		27-M6	100	174188
		27-M8	100	124382
		27-M10	100	181577
11-10	Vijak s kladivasto glavo HM 27	Skupina: 2715		
		HM 27 M8 x 25/14	50	106485
		HM 27 M8 x 100/14	50	410692
		HM 27 M10 x 25/14	50	106500
		HM 27 M10 x 50/14	50	410755
		HM 27 M10 x 80/14	50	410764
		HM 27 M10 x 100/14	50	410773
11-10	Kapica ADK 27	Skupina: 2704		
		27/15	100	193969
		27/25	100	111463
		27/27	100	193976
		27/37	100	110571

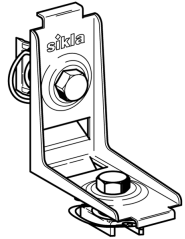
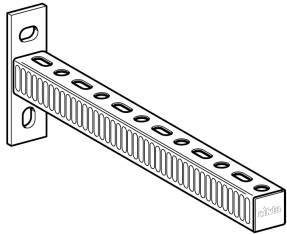
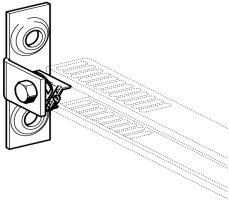
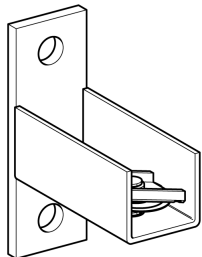
Stran	Produkt	Artikel	Pakirano	Artikel-št.
11-11	Kotnik CN CC 27-90° 	Skupina: 2726		
		CC 27-90°	50	195772
		CC 27-90° W	50	195789
11-12	Previsna konzola AK 27 	Skupina: 2754		
		27/25 - 200	25	112326
		27/25 - 250	25	112327
		27/25 - 300	25	112328
		27/25 - 500	25	112329
		27/25 - 700	1	112330
		27/25 q - 300	25	112366
		27/37 - 300	25	111458
		27/37 - 500	25	111459
		27/37 - 700	1	111460
		27/37 - 800	1	111461
11-13	Montažni set MOS 27 	Skupina: 2730		
		MV 27	10	195871
	Tip MV			
11-14	Držalo MOF 27 	Skupina: 2753		
		MH 27	25	198858
		MV 27	25	198865
	Tip MH			

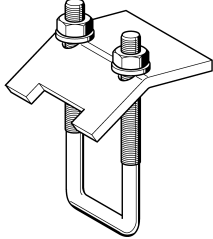
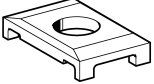
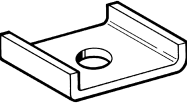
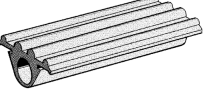

Stran	Produkt	Artikel	Pakirano	Artikel-št.
	navojno streme SB 27	Skupina: 2731 27 - M8	20	195864
				
11-16	Ozobje kljukasto HK 27	Skupina: 2727 27/10	50	114422
				
11-16	Ozobje držno HK L 27	Skupina: 2727 L27/10	50	114909
				
11-17	Profilna guma SAL 27	Skupina: 2710 27/30 na tekoči-m 27/L100 mm	1 rola 100	195963 195970
				

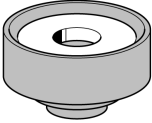
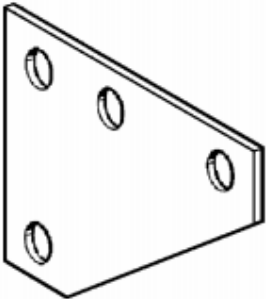
Stran	Produkt	Artikel	Pakirano	Artikel-št.
11-17	Zvočno izolacijski element 27	Skupina: 2712		
		27	00	197973
11-17	Vozliščne plošče KNO 27	Skupina: 1351		
		KNO 1	10	107769



Stran	Produkt	Artikel	Pakirano	Artikel-št.
12-2	NOMIC DUO	Skupina: 6110		
		DUO 50	1	149310
		DUO 70	1	149329
		DUO 80	1	410656
		DUO 100	1	149338
		DUO 125	1	149347
		DUO 150	1	149356
		DUO 200	1	149365
		DUO 250	1	149374
		DUO 300	1	149383
12-3	Rapid-W2	Skupina: 3181		
		DN 50	100	182135
		DN 70	100	182144
		DN 80	100	190055
		DN 100	100	182153
		DN 125	70	182162
		DN 150	50	182171
		DN 200	15	182180
12-4	NOMIC GRIP	Skupina: 3130		
		GRIP 50	1	149499
		GRIP 70	1	149505
		GRIP 80	1	410665
		GRIP 100	1	149514
		GRIP 125	1	149523
		GRIP 150	1	149532
		GRIP 200	1	149444
12-5	NOMFIX	Skupina: 3160		
		50	25	149596
		70	25	149602
		100	25	149611
		125	10	149620

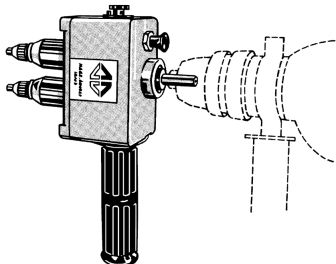
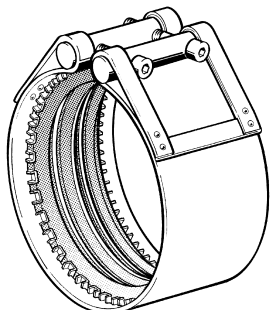
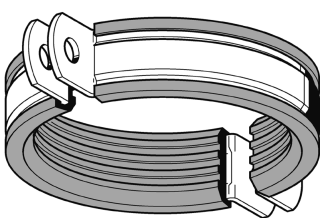

Stran	Produkt	Artikel	Pakirano	Artikel-št.
12-5	NOMIC DUOMAT	Skupina: 5143		
		DUOMAT	1	149639
12-6	SHARK-KR	Skupina: 3170		
		KR 50	25	162665
		KR 70	25	162674
		KR 80	25	192305
		KR 100	25	162683
		KR 100 A	25	162692
		KR 125 A	10	162708
		KR 150 A	10	162717
		KR 200 A	10	162726
12-7	Konzola za vertikalno SFK	Skupina: 1341		
	Objemko je potrebno naročiti posebej!	SFK	5	105110
12-7	Stabil D z o. za vertikalno SFK	Skupina: 1239		
		108 - 115	25	408128
		131 - 137	10	408146
		156 - 162	10	408173

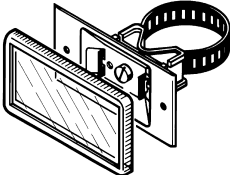
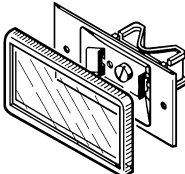
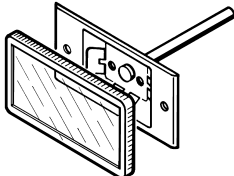
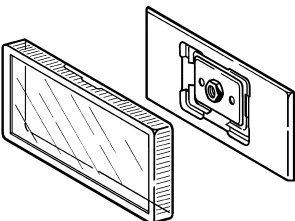

Stran	Produkt	Artikel	Pakirano	Artikel-št.
13-3	UNI z vpenjalnim trakom 	Skupina: 6101		
		Tablica z vpenjalnim trakom	25	127552
		Tablica A2 z vpenjalnim trakom	25	127464
13-3	UNI brez vpenjalnega traku 	Skupina: 6101		
		Tablica brez vpenjalnega traka	25	127163
		Tablica A2 brez vpenjalnega traka	25	127491
13-4	Privarilna tablica UNI 	Skupina: 6101		
		Privarilna tablica	25	127561
13-4	Privijalna tablica SHT 	Skupina: 6101		
		Privijalna tablica	25	127570
		Privijalna tablica A2	25	127473

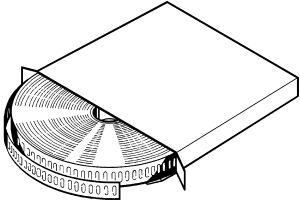
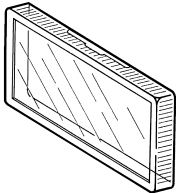
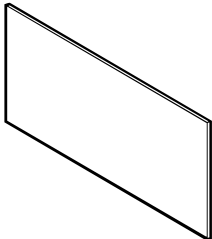

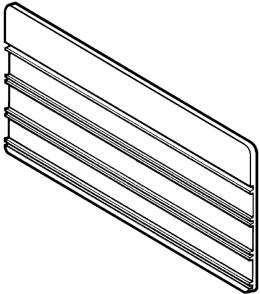
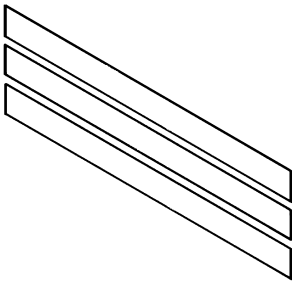
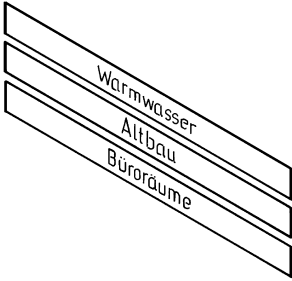
Stran	Produkt	Artikel	Pakirano	Artikel-št.
13-5	Vpenjalni trak LOH 	Skupina: 6112		
		Vpenjalni trak - alu	12	127598
		Vpenjalni trak A2	12	113005
13-5	Prozoren pokrov SHA 	Skupina: 6112		
		SHA	25	127589
13-6	Tablice LOG - barvne 	Skupina: 2130		
		rdeča-bela 100 x 50 x 1,5	50	127686
		modra-bela 100 x 50 x 1,5	50	127695
		zelena-bela 100 x 50 x 1,5	50	127701
		rumena-bela 100 x 50 x 1,5	50	127710
		črna-bela 100 x 50 x 1,5	50	127729
		siva-bela 100 x 50 x 1,5	50	127747
		bela-bela 100 x 50 x 1,5	50	127756
		lila-bela 100 x 50 x 1,5	50	410791
		rjava-bela 100 x 50 x 1,5	50	410800
		oranžna-bela 100 x 50 x 1,5	50	410809
		rumena-črna 100 x 50 x 1,5	50	410971
		bela-črna 100 x 50 x 1,5	50	410980
		črna-bela 200 x 100 x 1,5	50	410935
		modra-bela 200 x 100 x 1,5	50	410944
		zelena-bela 200 x 100 x 1,5	50	410953
		rdeča-bela 200 x 100 x 1,5	50	410962
rumena-črna 200 x 100 x 1,5	50	410989		
bela-črna 200 x 100 x 1,5	50	410998		

Stran	Produkt	Artikel	Pakirano	Artikel-št.
13-7	Tablica z utori LOGN	Skupina: 6130		
		bela	25	127677
		rumena	25	127631
		oranžna	25	127640
		rdeča	25	127604
		modra	25	127613
		zelena	25	127622
		siva	25	127668
		rjava	25	127659
13-7	Prazna letev SLL	Skupina: 6130		
		SLL	10	128401
13-7	Letev z napisom	Skupina: 2130		
		Tekst po želji	1	127941





Stran	Produkt	Artikel	Pakirano	Artikel-št.	
13-8	Tablica LOG barvna, beli napis	Skupina: 2131			
		100 x 50 x 1,5 - 1 zlg.	1	127853	
		100 x 50 x 1,5 - 2 zlg.	1	127862	
		100 x 50 x 1,5 - 3 zlg.	1	127871	
		100 x 50 x 1,5 - 4 zlg.	1	127880	
		100 x 50 x 1,5 - 5 zlg.	1	419000	
		100 x 50 x 1,5 - 6 zlg.	1	419001	
		200 x 100 x 1,5 - 1 zlg.	1	407003	
		200 x 100 x 1,5 - 2 zlg.	1	407012	
		200 x 100 x 1,5 - 3 zlg.	1	407021	
		200 x 100 x 1,5 - 4 zlg.	1	407030	
		200 x 100 x 1,5 - 5 zlg.	1	407039	
		200 x 100 x 1,5 - 6 zlg.	1	419002	
		200 x 100 x 1,5 - 7 zlg.	1	419003	
		200 x 100 x 1,5 - 8 zlg.	1	419004	
		200 x 100 x 1,5 - 9 zlg.	1	419005	
		200 x 100 x 1,5 - 10 zlg.	1	419006	
13-9		Tablica LOG barvna, črn napis	Skupina: 2129		
		100 x 50 x 1,5 - 1 zlg.	1	407048	
		100 x 50 x 1,5 - 2 zlg.	1	407057	
		100 x 50 x 1,5 - 3 zlg.	1	407066	
		100 x 50 x 1,5 - 4 zlg.	1	407075	
		100 x 50 x 1,5 - 5 zlg.	1	419007	
		100 x 50 x 1,5 - 6 zlg.	1	419008	
		200 x 100 x 1,5 - 1 zlg.	1	407084	
		200 x 100 x 1,5 - 2 zlg.	1	407093	
		200 x 100 x 1,5 - 3 zlg.	1	407102	
		200 x 100 x 1,5 - 4 zlg.	1	407111	
		200 x 100 x 1,5 - 5 zlg.	1	407120	
		200 x 100 x 1,5 - 6 zlg.	1	419009	
		200 x 100 x 1,5 - 7 zlg.	1	419010	
		200 x 100 x 1,5 - 8 zlg.	1	419011	
		200 x 100 x 1,5 - 9 zlg.	1	419012	
		200 x 100 x 1,5 - 10 zlg.	1	419013	



Stran	Produkt	Artikel	Pakirano	Artikel-št.
13-10	Lepilni trak - dvostranski	Skupina: 6902		
		100 x 50	1	407147
		200 x 100	1	407156
13-10	Vtisk	Skupina: 6902		
		Logo podjetja	1	138149
13-10	Laserska obdelava	Skupina: 6902		
		Logo podjetja	1	138103
		Laserska obdelava logo podjetja	1	138121
13-11	Opozorilna tabla 100x50	Skupina: 2301		
		Tekst 1 - neprevlečena	10	417064
		Tekst 1 - samolepilna	10	417226
		Tekst 1 - samolepilna folija	10	417388
		Tekst 2 - neprevlečena	10	417073
		Tekst 2 - samolepilna	10	417235
		Tekst 2 - samolepilna folija	10	417397
		Tekst 3 - neprevlečena	10	417082
		Tekst 3 - samolepilna	10	417244
		Tekst 3 - samolepilna folija	10	417406
		Tekst 4 - neprevlečena	10	417091
		Tekst 4 - samolepilna	10	417253
		Tekst 4 - samolepilna folija	10	417415
		Tekst 5 - neprevlečena	10	417100
		Tekst 5 - samolepilna	10	417262
		Tekst 5 - samolepilna folija	10	417424
		Tekst 6 - neprevlečena	10	417109
		Tekst 6 - samolepilna	10	417271
		Tekst 6 - samolepilna folija	10	417433
		Tekst 7 - neprevlečena	10	417118
		Tekst 7 - samolepilna	10	417280
Tekst 7 - samolepilna folija	10	417442		
Tekst 8 - neprevlečena	10	417127		
Tekst 8 - samolepilna	10	417289		
Tekst 8 - samolepilna folija	10	417451		
Tekst 9 - neprevlečena	10	417136		
Tekst 9 - samolepilna	10	417298		
Tekst 9 - samolepilna folija	10	417460		

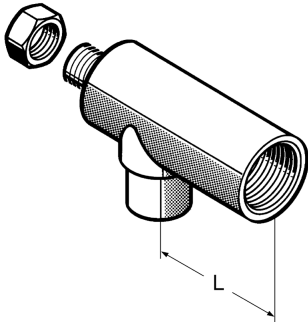

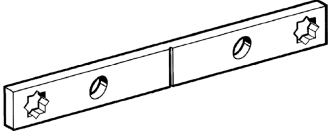
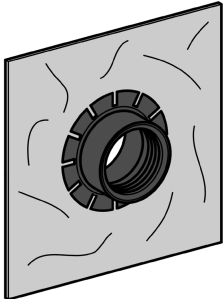
Stran	Produkt	Artikel	Pakirano	Artikel-št.
13-12	Opozorilna tabla 200x100	Skupina: 2301		
		Tekst 1 - neprevlečena	10	417145
		Tekst 1 - samolepilna	10	417307
		Tekst 1 - samolepilna folija	10	417469
		Tekst 2 - neprevlečena	10	417154
		Tekst 2 - samolepilna	10	417316
		Tekst 2 - samolepilna folija	10	417478
		Tekst 3 - neprevlečena	10	417163
		Tekst 3 - samolepilna	10	417325
		Tekst 3 - samolepilna folija	10	417487
		Tekst 4 - neprevlečena	10	417172
		Tekst 4 - samolepilna	10	417334
		Tekst 4 - samolepilna folija	10	417496
		Tekst 5 - neprevlečena	10	417181
		Tekst 5 - samolepilna	10	417343
		Tekst 5 - samolepilna folija	10	417505
		Tekst 6 - neprevlečena	10	417190
		Tekst 6 - samolepilna	10	417352
		Tekst 6 - samolepilna folija	10	417514
		Tekst 7 - neprevlečena	10	417199
		Tekst 7 - samolepilna	10	417361
		Tekst 7 - samolepilna folija	10	417523
		Tekst 8 - neprevlečena	10	417208
		Tekst 8 - samolepilna	10	417370
		Tekst 8 - samolepilna folija	10	417532
		Tekst 9 - neprevlečena	10	417217
		Tekst 9 - samolepilna	10	417379
		Tekst 9 - samolepilna folija	10	417541

Stran	Produkt	Artikel	Pakirano	Artikel-št.
14-5	SIMI Kotni priključek MS	Skupina: 4111		
		MS 45 - 1/2"	50	131443
		MS 45 - 15	50	131461
		MS 45 - 18	50	138015
		MS 65 - 1/2"	25	132152
		MS 65 - 15	25	132170
		MS 90 - 12	25	131489
		MS 90 - 15	25	131498
		MS 90 - 22	25	139645
		MS 150 - 12	25	131568
		MS 150 - 15	25	131577
		MS 150 - 18	25	131586
		MS 150 - 22	25	131595
14-6		Čep iz medenine MSP	Skupina: 4110	
		1/2"	50	140366
14-6	Distančna plošča DE	Skupina: 4110		
		100	10	131629
		120	10	131638
		153	10	131647
		160	10	139876
		200	10	131665
		Posamezen priključek	10	131683
14-7		SIMI tesnilna manšeta	Skupina: 4112	
		1/2"	10	169219

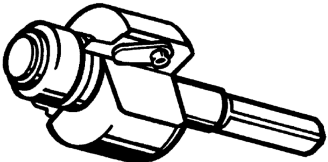

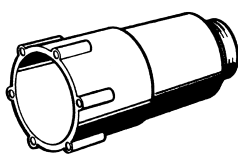
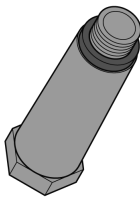
Stran	Produkt	Artikel	Pakirano	Artikel-št.
14-7	Specialno stoščasto rezkalo	Skupina: 5102 1/2"	1	131601
				
14-8	Set obračalnih plošč za rezkalo	Skupina: 5102 Set obračalnih plošč za rezkalo	1	174233
				
14-8	Gradbeni čep MS tesnilni	Skupina: 5905 rdeč 1/2" moder 1/2"	10 10	406138 406147
				
14-9	Gradbeni čep BS - MD	Skupina: 5905 rdeč 1/2" moder 1/2"	25 25	411781 411790
				

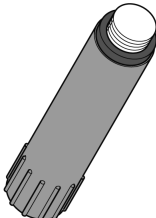
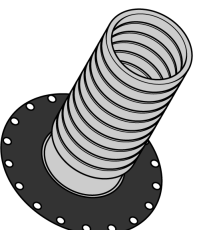
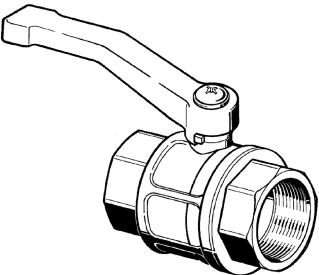
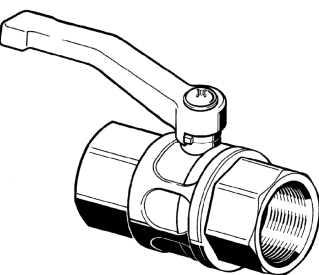
Stran	Produkt	Artikel	Pakirano	Artikel-št.
14-9	Gradbeni čep BS - MSMD	Skupina: 5905		
		rdeč $\frac{1}{2}$ "	10	411799
		moder $\frac{1}{2}$ "	10	411808
14-10	Gradbena tuljava OHA	Skupina: 5905		
		Gradbena tuljava OHA - tesnilo	25	410449
14-11	Kroglični ventil KGH 300	Skupina: 4620		
		300 - $\frac{3}{8}$ "	12	403105
		300 - $\frac{1}{2}$ "	10	403114
		300 - $\frac{3}{4}$ "	8	403123
		300 - 1"	4	403132
		300 - 1 $\frac{1}{4}$ "	2	403141
		300 - 1 $\frac{1}{2}$ "	2	403150
		300 - 2"	2	403159
14-12	Kroglični ventil KGH 380	Skupina: 4622		
		380 - $\frac{3}{8}$ "	12	403474
		380 - $\frac{1}{2}$ "	10	120281
		380 - $\frac{3}{4}$ "	6	120290
		380 - 1"	4	120306
		380 - 1 $\frac{1}{4}$ "	5	120315
		380 - 1 $\frac{1}{2}$ "	3	120342
		380 - 2"	2	120351
		380 - 2 $\frac{1}{2}$ "	1	403285
		380 - 3"	1	403294

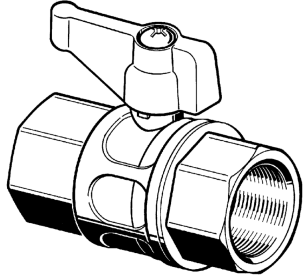
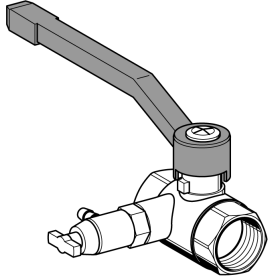
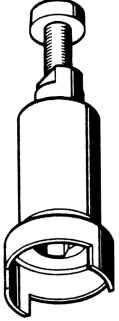
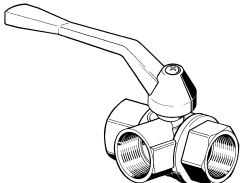

Stran	Produkt	Artikel	Pakirano	Artikel-št.
14-13	Kroglični ventil KGH 381	Skupina: 4622		
		381 - 1/2"	10	405768
		381 - 3/4"	6	405777
		381 - 1"	4	405786
		381 - 1 1/4"	6	405795
14-14	Ventil KGH 376 z izpustom	Skupina: 4621		
		376 - 1/2"	8	411511
		376 - 3/4"	6	411520
		376 - 1"	4	411529
		376 - 1 1/4"	2	411538
		376 - 1 1/2"	1	411547
		376 - 2"	1	411556
14-15	Podaljšek vretena SVL	Skupina: 4613		
		287	1	403303
		288	1	403312
		289/1	1	413401
		289	1	403321
		267/1	1	413402
		267	1	403438
		267/F	1	413403
14-16	Ventil 3-potni krog. KGH 181 T	Skupina: 4623		
		181T - 3/8"	5	403600
		181T - 1/2"	5	403609
		181T - 3/4"	4	403618
		181T - 1"	4	403627
		181T - 1 1/4"	2	403636
		181T - 1 1/2"	2	403717

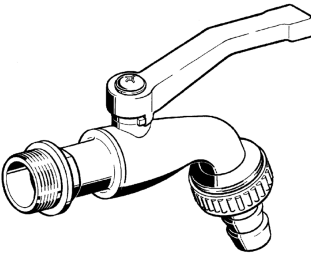
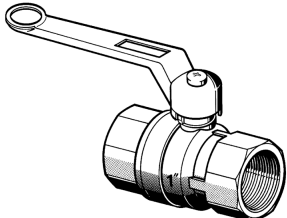
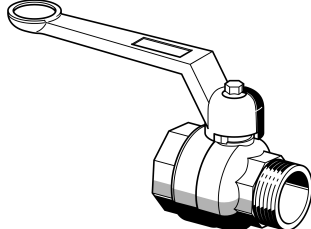
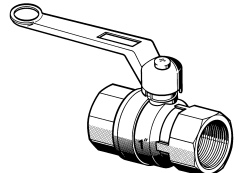
Stran	Produkt	Artikel	Pakirano	Artikel-št.
14-17	Izpustni ventil KAH	Skupina: 4624		
		186 - 1/2"	5	120494
		186 - 3/4"	3	122900
14-18	Kroglični ventil KGH 491	Skupina: 4615		
		491/1 - 3/8"	10	152291
		491/1 - 1/2"	10	152307
		491/1 - 3/4"	10	152316
		491/1 - 1"	10	152325
		491/1 - 1 1/4"	10	152334
		491/1 - 1 1/2"	10	152343
		491/1 - 2"	10	152352
14-19	Kroglični ventil KGH 491 FM	Skupina: 4626		
		491 FM - 1/2"	10	406183
		491 FM - 3/4"	10	406192
		491 FM - 1"	8	406201
		491 FM - 1 1/4"	7	406210
		491 FM - 1 1/2"	3	406219
14-20	Kroglični ventil KGH 593	Skupina: 4625		
		593 - 3/8"	10	122247
		593 - 1/2"	25	403645
		593 - 3/4"	15	403654
		593 - 1"	8	120838
		593 - 1 1/4"	7	120847
		593 - 1 1/2"	3	120856
		593 - 2"	2	120953



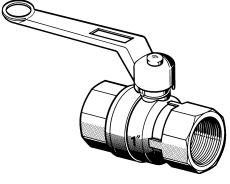
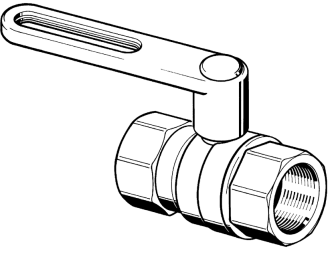
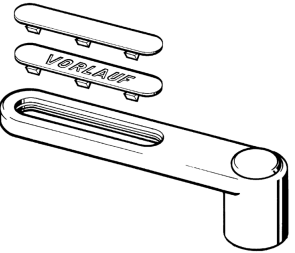

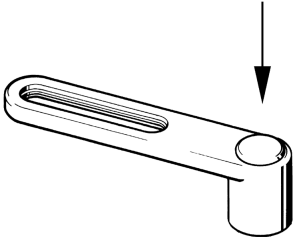
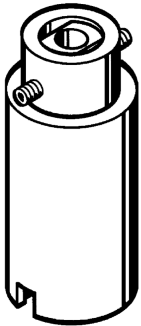
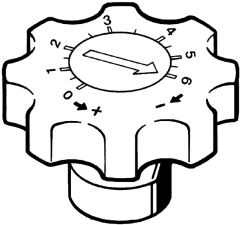
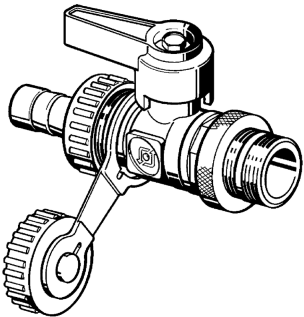
Stran	Produkt	Artikel	Pakirano	Artikel-št.
14-21	Kroglični ventil KGH 594	Skupina: 4609		
		594 - 3/8"	10	105855
		594 - 1/2"	25	105864
		594 - 3/4"	15	105873
		594 - 1"	8	105882
		594 - 1 1/4"	7	105891
		594 - 1 1/2"	3	105907
		594 - 2"	2	105916
		594 - 2 1/2"	5	414769
		594 - 3"	2	414778
		594 - 4"	1	414787
14-22	Ventil KGH 594 Multilogo	Skupina: 4609		
		594 - 3/8"	2	407507
		594 - 1/2"	2	407516
		594 - 3/4"	2	407525
		594 - 1"	2	407534
		594 - 1 1/4"	2	407543
		594 - 1 1/2"	2	407552
		594 - 2"	2	407561
14-23	Multilogo MLG napisne tablice	Skupina: 4617		
		rdeča	20	407687
		modra	20	407696
		zelena	20	407705
		rumena	20	407714
		bela	20	407723
		rdeča - Tekst 1	20	413554
		modra - Tekst 2	20	413563
		rdeča - Tekst 3	20	413572
		modra - Tekst 4	20	413581
		rdeča - Tekst 5	20	413590
		modra - Tekst 6	20	413599
		rdeča - Tekst 7	20	413608
		zelena - Tekst 8	20	413617
		bela - Tekst 9	20	413626
		zelena - Tekst 10	20	413635
		rdeča - Tekst 11	20	413644
		modra - Tekst 12	20	413653
		rdeča - Tekst 13	20	413662
		modra - Tekst 14	20	413671

Stran	Produkt	Artikel	Pakirano	Artikel-št.
14-24	Multilogo MLG zaklj. pokrov	Skupina: 4617		
		rdeč	20	407732
		moder	20	407741
		zelen	20	407750
		rumen	20	407759
		bel	20	407768
14-25	Podaljšek vretena SVL 010	Skupina: 4613		
		010 - 1 35	1	105989
		010 - 2 45	1	105998
		010 - 3 60	1	106005
14-25	Ročka za mehko zapiranje SSG	Skupina: 4613		
		011 - 1	1	105952
		011 - 2	1	105961
		011 - 3	1	105970
14-26	KFE ventil 275	Skupina: 4616		
		$\frac{1}{2}$ " brez nastavka za gipko cev	10	405813
		$\frac{1}{2}$ " z nastavkom za gipko cev	10	152398
		Nastavek s tesnilom za gipko cev	1	405976

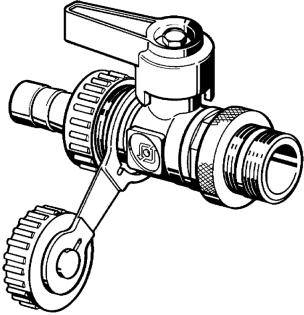
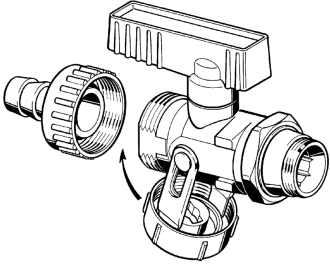
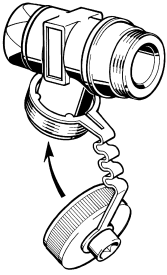

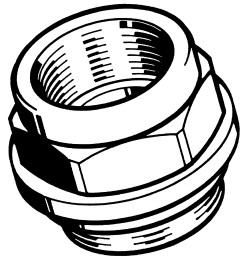
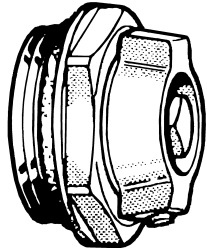
Stran	Produkt	Artikel	Pakirano	Artikel-št.
14-27	KFE ventil 275 Solar	Skupina: 4616 1/2" brez nastavka za gipko cev	10	405804
				
14-28	FE ventil PN 16 Ekskluziv	Skupina: 4616 FE-PN 16 Nast. za gipko cev 1/2"	10	403789
				
14-29	Izpustni ventil ELV	Skupina: 4303 3/8" 1/2"	25 25	403465 131106
				

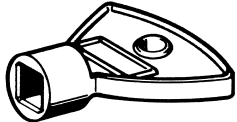
Stran	Produkt	Artikel	Pakirano	Artikel-št.
14-29	Radiatorski reducirni čep HKRS	Skupina: 4305 $\frac{1}{2}'' \times \frac{3}{8}''$	50	403816
				
14-30	Radiatorski odzračevalni čep	Skupina: 4305 $\frac{1}{2}''$	50	403834
				
14-30	Radiatorski slepi čep HKBS	Skupina: 4305 $\frac{1}{2}''$	50	403825
				
14-30	Štiri robni ključ za odzrač.	Skupina: 4305 4 - 5 mm	100	131902
				

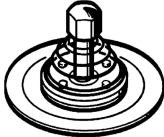
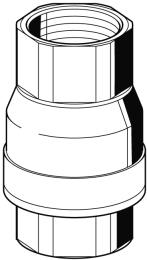
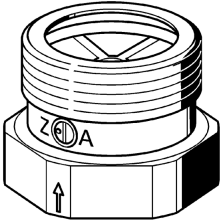
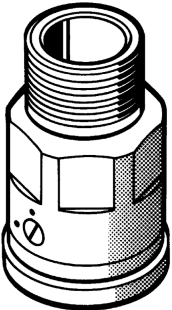

Stran	Produkt	Artikel	Pakirano	Artikel-št.
14-31	Odzračevalnik SE	Skupina: 4202		
		SE vklj. filter in vzmetna zapora $\frac{3}{8}$ "	12	131735
		SE vklj. filter in vzmetna zapora $\frac{1}{2}$ "	12	405930
		SE vklj. vzmetna zapora $\frac{3}{8}$ "	12	405948
		SE vklj. vzmetna zapora $\frac{1}{2}$ "	12	405957
		Odzračevalnik $\frac{3}{8}$ " posamezno	12	405822
		Filter za SE posamezno	6	157515
14-32	Odzračevalnik kotni SE-E	Skupina: 4202		
		SE-E 115 $\frac{1}{2}$ "	10	405960
14-33	Odzračevalnik ATR 124	Skupina: 4203		
		$\frac{3}{4}$ "	1	410395
		1"	1	410404
		1 $\frac{1}{4}$ "	1	410413

Stran	Produkt	Artikel	Pakirano	Artikel-št.
14-34	Fermat ventil	Skupina: 4301		
		Fermat $\frac{3}{4}$ "	1	131726
		Fermat 1"	1	131692
		Fermat 1 $\frac{1}{4}$ "	1	131708
		Fermat 1 $\frac{1}{2}$ "	1	131717
14-35	Zapora za hidrav. udar RSV 235	Skupina: 4304		
		$\frac{1}{2}$ "	1	406290
		$\frac{3}{4}$ "	1	406291
		1"	1	406292
		1 $\frac{1}{4}$ "	1	406293
		1 $\frac{1}{2}$ "	1	406294
		2"	1	406295
14-36	Gravitacijska zavora SWK	Skupina: 4306		
	 	SBM 1" k	12	130974
		SBM 1 $\frac{1}{4}$ "	12	130992
		SBE AG 1"	12	131018
		SBE IG 1"	12	131036

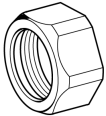
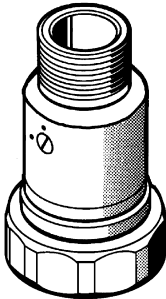

Stran	Produkt	Artikel	Pakirano	Artikel-št.
14-37	Prekrivna matica NT SBE	Skupina: 4306 DN 1"	12	411322
				
14-37	Gravitacijska zapora SWK SFR	Skupina: 4306 SFR 1" SFR 1 1/4"	1 1	131993 132000
				

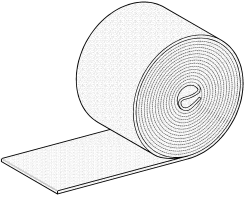
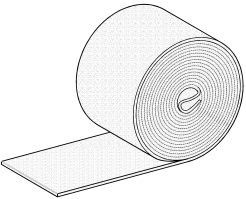
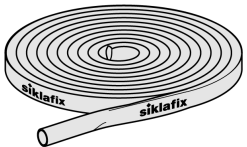
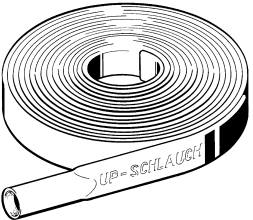
Stran	Produkt	Artikel	Pakirano	Artikel-št.
15-5	Sikla - standard	Skupina: 3506		
		70 N	192	129484
15-5	Sikla - super	Skupina: 3507		
		70 SU	192	129299
15-6	Siklafix - izolacijska cev	Skupina: 3505		
		3 - 15	340	137449
		4 - $\frac{3}{8}$ "	320	129387
		4 - $\frac{1}{2}$ "	300	129396
		4 - $\frac{3}{4}$ "	150	129402
		4 - 1"	120	129411
		4 - 1 $\frac{1}{4}$ "	100	129420
15-7	UP Stabil - izolacijska cev	Skupina: 3504		
		4 - 15	220	101240
		4 - $\frac{3}{8}$ "	200	101259
		4 - $\frac{1}{2}$ "	180	101268
		4 - $\frac{3}{4}$ "	150	101277
		4 - 1"	120	101286
		4 - 1 $\frac{1}{4}$ "	100	101295
		4 - 50	70	101301
		4 - 70	60	101310
		4 - 100	40	101329
		4 - 125	30	101338
		4 - 150	30	101347

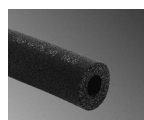

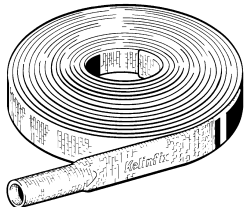
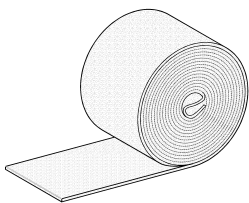
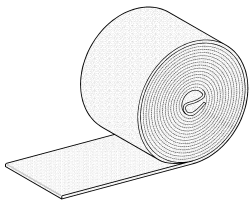

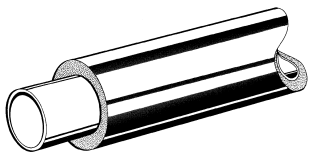
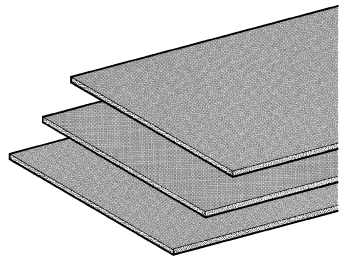
Stran	Produkt	Artikel	Pakirano	Artikel-št.
15-8	Kelifix - izolacijska cev 	Skupina: 3502		
		4 - 15	220	101426
		4 - $\frac{3}{8}$ "	200	101435
		4 - $\frac{1}{2}$ "	180	101444
		4 - $\frac{3}{4}$ "	150	101453
		4 - 1"	120	101462
		4 - 1 $\frac{1}{4}$ "	100	101471
		4 - 50	70	101374
		4 - 70	60	101383
		4 - 100	40	101392
		4 - 125	30	405831
		4 - 150	30	405840
15-9	UP izolacijski trak PE 	Skupina: 3501		
		70 K	100	150138
		70 K selbstklebend	100	407399
15-9	Kelifix - izolacijski trak 	Skupina: 3501		
		70 K	100	101417

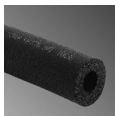
Stran	Produkt	Artikel	Pakirano	Artikel-št.
15-10	Climaflex CFX B1	Skupina: 3701		
		9 x 15	380	130239
		9 x 18	330	130248
		9 x 22	250	130257
		9 x 28	190	130266
		9 x 35	150	130275
		9 x 42	110	130284
		9 x 48	90	130293
		9 x 60	66	130318
		9 x 76	48	130734
		9 x 89	40	144148
		13 x 15	256	135809
		13 x 18	220	130336
		13 x 22	180	135818
		13 x 28	140	135827
		13 x 35	120	144218
		13 x 42	90	144236
		13 x 48	70	144254
		13 x 60	48	144272
		13 x 76	40	144290
		13 x 89	30	144430
		13 x 114	22	144412
		20 x 22	108	135784
		20 x 28	96	135836
		20 x 35	70	135845
		20 x 42	60	135793
		20 x 48	48	144360
		20 x 60	40	144388
		20 x 76	26	144403
		20 x 89	24	407327
	20 x 114	14	407336	
15-12	Kelon - B1 izolacijske ploče	Skupina: 3707		
		SHP 9	15	143280
		SHP 18	8	143305



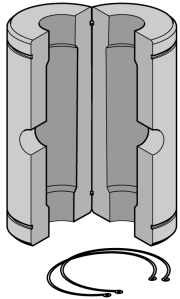
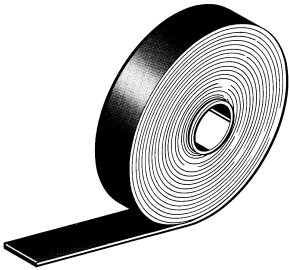

Stran	Produkt	Artikel	Pakirano	Artikel-št.	
15-12	Kelon B1 - izolacija v roli	Skupina: 3707			
		SHP 9	1	405849	
		SHP18	1	405867	
15-13	Climaflex CFX B1 SV	Skupina: 3705			
		9 - 15	300	407345	
		9 - 18	300	407354	
		9 - 22	250	407363	
		9 - 28	190	407372	
		9 - 35	150	407381	
		13 - 15	200	161123	
		13 - 18	190	161132	
		13 - 22	160	161141	
		13 - 28	130	161150	
		13 - 35	102	161169	
		13 - 42	84	161178	
		13 - 48	70	161187	
		13 - 60	48	161196	
15-14		Climaflex CFX B1 Stabil	Skupina: 3710		
			9 - 15	120	161202
			9 - 18	120	161211
	9 - 22		100	161220	
	9 - 28		90	161239	
	9 - 35		60	161248	
	9 - 42		48	407390	
	13 - 15		100	161257	
	13 - 18		96	161266	
	13 - 22		80	161275	
	13 - 28		64	161284	
	13 - 35		48	161293	

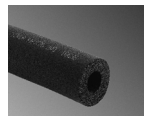
Stran	Produkt	Artikel	Pakirano	Artikel-št.
15-15	Climaflex CFX izolacijska kapa	Skupina: 3704		
	 <p>Tip KHV</p>	KHV DN 15	15	416030
		KHV DN 20	10	416031
		KHV DN 25	10	416032
		KHV DN 32	9	416033
		KHV DN 40	12	416034
		SSV DN 15	20	416038
		SSV DN 20	20	416047
		SSV DN 25	15	416056
		SSV DN 32	10	416065
		SSV DN 40	5	416074
		SSV DN 50	4	416083
		ZV DN 15	10	416021
		ZV DN 20	9	416022
		ZV DN 25	5	416023
15-16		Kelon - izolacijski trak	Skupina: 3703	
		50 x 3	12	115946
15-16	Kelon Climaflex B1 - lepilo	Skupina: 3702		
		Ena pločevinka - 0,5l	1	404176

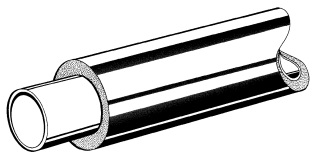

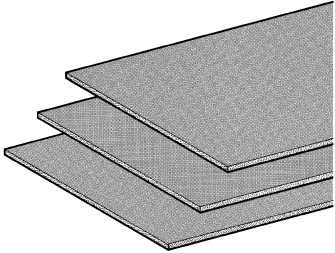
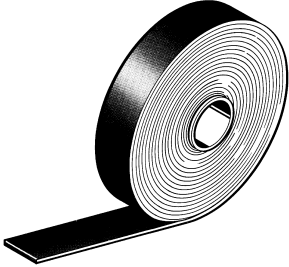

Stran	Produkt	Artikel	Pakirano	Artikel-št.
15-17	Eurobatex C1 B1	Skupina: 3219		
		6 x 16	150	158978
		6 x 18	180	158987
		6 x 22	130	158996
		9 x 10	190	154141
		9 x 14	160	154150
		9 x 18	130	154169
		9 x 22	100	154178
		9 x 28	80	154187
		9 x 34	60	154196
		9 x 42	50	154202
		9 x 48	48	154220
		9 x 57	42	410701
		9 x 60	42	154257
		9 x 64	40	154266
		9 x 76	34	154284
		9 x 90	26	154293
		9 x 114	20	154318
		13 x 10	70	154336
		13 x 14	110	154345
		13 x 18	90	154354
		13 x 22	70	154363
		13 x 28	60	154372
		13 x 34	48	156903
		13 x 42	38	156912
		13 x 48	34	158835
		13 x 57	30	410710
		13 x 60	30	158844
		13 x 76	24	158853
		13 x 90	20	158862
		13 x 114	16	158871
		13 x 133	10	411637
		13 x 160	6	411646
		19 x 10	132	158880
		19 x 14	60	158899
		19 x 18	60	158905
		19 x 22	44	158914
		19 x 28	40	154381
		19 x 34	30	154390
		19 x 42	28	154406
		19 x 48	26	158923
		19 x 57	20	410719
		19 x 60	20	158932
		19 x 76	16	158941
		19 x 90	14	158950
		19 x 114	14	158969
	19 x 133	8	411655	
	19 x 160	6	411664	
	25 x 22	30	154512	
	25 x 28	26	154521	
	25 x 34	22	156055	

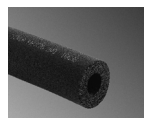

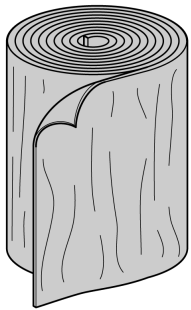
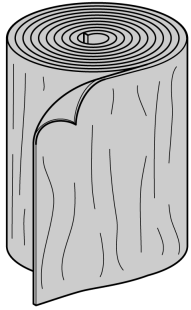
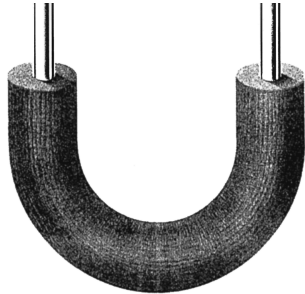
Stran	Produkt	Artikel	Pakirano	Artikel-št.
		25 x 42	18	154415
		25 x 48	14	154433
		32 x 60	12	154460
		40 x 48	12	156073
15-19	Eurobatex C1 B1 izo. plošče	Skupina: 3223		
		PL - 9	16	154035
		PL - 13	12	154044
		PL - 19	8	154053
15-19	Eurobatex izolacijski trak	Skupina: 3224		
		50 x 3 – rola 10 m	24	154071
15-19	Eurobatex C1 lepilo	Skupina: 3235		
		Ena pločevinka 425 g	1	153991

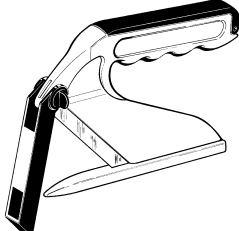

Stran	Produkt	Artikel	Pakirano	Artikel-št.
15-20	Eurobatex ETX C1 B1 rola	Skupina: 3225		
		RL - 9	20	411961
		RL - 13	14	411970
		RL - 19	10	411979
		RL - 25	8	411988
15-20	Eurobatex ETX C1 B1 rola SK	Skupina: 3226		
		RL - 9 SK	20	412114
		RL - 13 SK	14	412123
		RL - 19 SK	10	412132
		RL - 25 SK	8	412141
15-21	Eurobatex AT solar	Skupina: 3401		
		13 x 18	90	415894
		13 x 22	70	415903
		19 x 18	60	416020
		19 x 22	44	416029
		19 x 28	40	416037
		19 x 34	30	416046

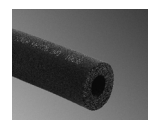
Stran	Produkt	Artikel	Pakirano	Artikel-št.
15-22	Eurobatex AT Kleber 	Skupina: 3235 Pločevinka 250 ml vklj. s trdilcem	1	405912
15-22	Čistilo 	Skupina: 3702 Pločevinka 1,0 Liter	1	404185
15-22	Nož za rezanje izolacije - veliki 	Skupina: 5407 Nož za rezanje izolacije	1	402709

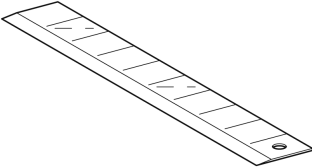
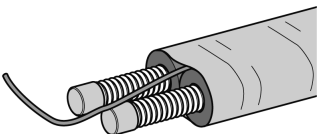

Stran	Produkt	Artikel	Pakirano	Artikel-št.
15-22	Rezervno rezilo za nož	Skupina: 5407		
		Rezervno rezilo za nož - mali	10	132718
		Rezervno rezilo za nož - veliki	10	402718
15-23	Insul-Tube solar ITS	Skupina: 3236		
		13-16mm / 10m	10	411439
		13-16mm / 15m	15	411440
		13-16mm / 20m	20	411441
		13-16mm / 25m	25	411442
		13-16mm / 50m	50	411443
		13-20mm / 10m	10	411444
		13-20mm / 15m	15	411445
		13-20mm / 20m	20	411446
		13-20mm / 25m	25	411447
		13-20mm / 50m	50	411448
		13-25mm / 10m	10	411449
		13-25mm / 15m	15	411450
		13-25mm / 20m	20	411451
		13-25mm / 25m	25	411452
	13-25mm / 50m	50	411453	
15-24	Insul-Tube solar ITS SBD	Skupina: 3236		
		SBD	30	411455

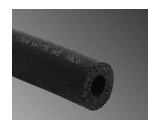

Stran	Produkt	Artikel	Pakirano	Artikel-št.
15-25	Vijačni set VSS	Skupina: 3237		
		DN 16	10	409262
		DN 20	10	409263
		DN 25	10	409264
15-25	Pritrdilni set BFS	Skupina: 3238		
		DN 16	10	409208
		DN 20/25	10	409209
15-26	Privijalo VSB	Skupina: 4114		
		AG 3/4" DN 16	10	412807
		AG 3/4" DN 20	10	412808
		AG 1" DN 20	10	412809
		IG 3/4" DN 16	10	412810
		IG 3/4" DN 20	10	412811
		IG 1" DN 20	10	412812
15-27	Dvojno privijalo DKG	Skupina: 4114		
		DN 16	10	412798
		DN 20	10	412799

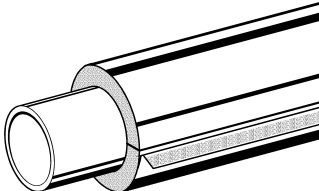

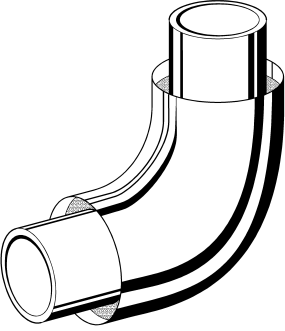
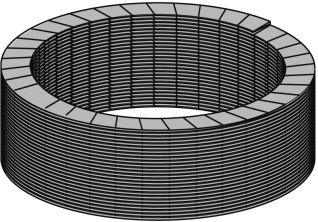
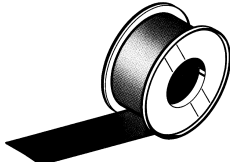
Stran	Produkt	Artikel	Pakirano	Artikel-št.
15-28	Dvovijačnik DNFD	Skupina: 4114		
		³ / ₄ " DN 16	20	413527
		1" DN 20	20	413536
		1 ¹ / ₄ " DN 25	10	413545
15-29	PUR - čaše	Skupina: 5812		
		040 15 - 20	63	409280
		040 18 - 20	63	409289
		040 22 - 20	55	409298
		040 28 - 20	48	409306
		040 35 - 20	36	409315
		040 42 - 20	28	409333
		040 48 - 20	24	409351
		040 60 - 20	22	409369
		040 76 - 20	14	409387
		040 89 - 20	13	409396
		040 114 - 20	8	409405

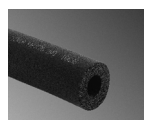
Stran	Produkt	Artikel	Pakirano	Artikel-št.
15-30	PUR univerzalno koleno	Skupina: 5813		
		040 / 035 18 - 20	20	409414
		040 / 035 22 - 20	20	409423
		040 28 - 20	20	409432
		040 35 - 20	20	409441
		040 42 - 20	20	409459
		040 48 - 20	20	409477
		040 60 - 20	20	409495
		040 76 - 20	10	409513
		040 89 - 20	10	409522
		040 114 - 20	10	409531
		035 28 - 30	20	412870
		035 35 - 30	20	412879
		035 42 - 40	20	412888
		035 48 - 40	10	412897
		035 60 - 50	10	412906
15-31		Alu lamelni trak	Skupina: 5814	
		18 mm	5	409540
		23 mm	5	409549
		28 mm	5	409558
15-31	Anker izolirni trak	Skupina: 7523		
		rdeč	50	109789
		moder	50	109725

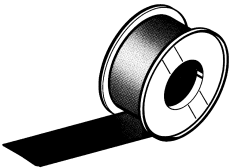

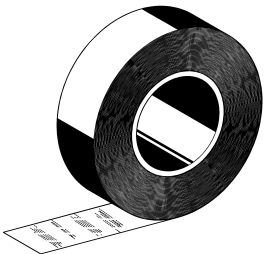
Stran	Produkt	Artikel	Pakirano	Artikel-št.
15-32	Alltape lepilni trak	Skupina: 7521		
		Svetlo siv 20	50	109327
		Svetlo siv 30	50	109336
		Svetlo siv 50	48	109345
		Svetlo siv 100	10	109354
		Temno siv 20	50	109390
		Temno siv 30	50	109318
		Temno siv 50	48	109363
		Temno siv 100	10	109293
		Črn 30	50	405094
		Črn 50	48	405103
		Rumen 30	50	405067
		Rumen 50	48	405076
		Rumen 100	10	405085
		Rdeč 30	50	405040
		Rdeč 50	48	405031
15-33		Sikla-Plast lepilni trak	Skupina: 7522	
		Svetlo siv 30	22	405993
		Svetlo siv 50	14	135854
		Temno sivu 30	22	135872
		Temno siv 50	14	135881
		oranžen 30	5	151476
		oranžen 50	4	151865
15-34	Coroplast 918 Alu-lepilni trak	Skupina: 7521		
		918/50	24	404401
		918/75	16	404410

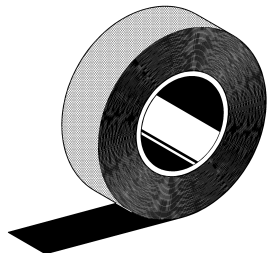
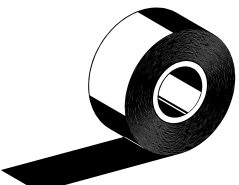
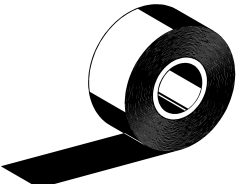
Stran	Produkt	Artikel	Pakirano	Artikel-št.
15-34	Coroplast 910 Alu-SE	Skupina: 7521		
		910 SE/50	24	126348
		910 SE/75	16	126339
				
15-35	Tkaninast trak 8200 silber	Skupina: 7521		
		8200 srebrn	24	405112
				
15-35	Denso trak 040	Skupina: 7502		
		040/50	12	109637
		040/75	12	109628
		040/100	6	109646
				
15-36	Denso trak KP	Skupina: 7502		
		KP/50	24	135924
		KP/100	12	135933
				

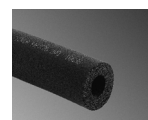

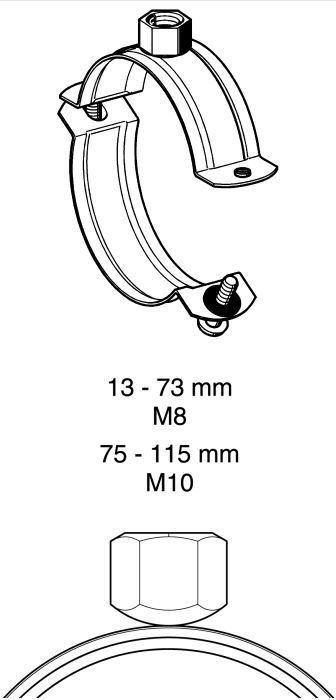
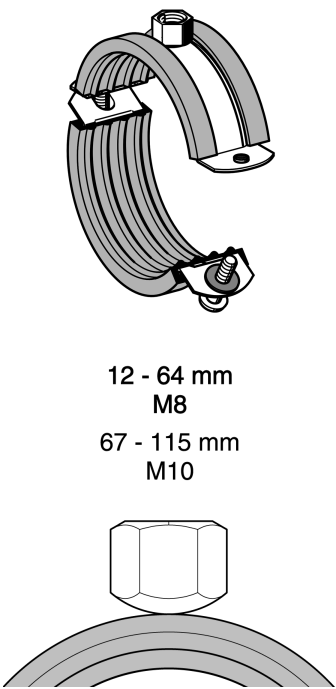
Stran	Produkt	Artikel	Pakirano	Artikel-št.
16-5	Vijačna objemka SRS VA	Skupina: 1722		
	 <p>13 - 73 mm M8</p> <p>75 - 115 mm M10</p>	13 - 18	100	170587
		19 - 22	100	170602
		27 - 30	100	170611
		32 - 36	100	170620
		40 - 44	50	170639
		48 - 54	50	170648
		60 - 66	50	170657
		68 - 73	25	173342
		75 - 80	25	170666
		84 - 89	25	170675
		102 - 108	25	173351
		110 - 115	25	170684
		129 - 140 *	25	110882
		159 - 169 *	25	110883
16-6		Vijačna objemka SRS VA z o.	Skupina: 1722	
	 <p>12 - 64 mm M8</p> <p>67 - 115 mm M10</p>	12 - 15	100	170693
		15 - 19	100	170709
		20 - 23	100	170718
		25 - 28	100	170727
		32 - 35	100	170736
		40 - 45	50	170745
		48 - 52	50	170754
		52 - 58	50	173360
		60 - 64	50	170763
		67 - 72	25	173369
		73 - 80	25	170772
		86 - 91	25	170781
		102 - 108	25	173378
		110 - 115	25	170790
		135 - 143	25	110884
	149 - 161	25	110885	
	162 - 170	25	110886	

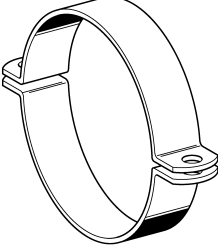
Stran	Produkt	Artikel	Pakirano	Artikel-št.
16-7	Stabil D VA	Skupina: 1739		
		15 - 19	50	145723
		20 - 24	50	145732
		25 - 30	50	145741
		31 - 35	50	145750
		36 - 41	50	145769
		40 - 45	50	145778
		48 - 53	50	145787
		54 - 59	50	145796
		60 - 65	50	145802
		67 - 72	25	145811
		76 - 81	25	145820
		82 - 87	25	145839
		88 - 93	25	145848
		102 - 108	25	145866
		110 - 116	25	145875
		124 - 129	25	145893
		133 - 140	10	145909
		149 - 155	10	145927
		159 - 165	10	145936
		167 - 173	10	145945
		176 - 182	10	145954
		188 - 194	10	145963
		199 - 205	10	145972
		210 - 219	10	414733
		247 - 253	10	413725
		271 - 277	10	413734
		312 - 318	10	413743
		322 - 329	10	413752

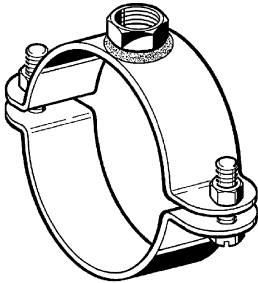
Stran	Produkt	Artikel	Pakirano	Artikel-št.
16-8	Stabil D-1G VA	Skupina: 1740		
		15 - 19 $\frac{3}{8}$ " M8	50	145097
		20 - 24 $\frac{1}{2}$ " M8	50	145103
		25 - 30 $\frac{3}{4}$ " M8	50	145112
		31 - 35 1" M10	50	145121
		36 - 41 M10	50	145130
		40 - 45 $1\frac{1}{4}$ " M10	50	145149
		48 - 53 $1\frac{1}{2}$ " M10	50	145158
		54 - 59 M10	50	145167
		60 - 65 2" M10	50	145176
		67 - 72 M10	50	145185
		76 - 81 $2\frac{1}{2}$ " M12	25	145194
		82 - 87 M12	25	145352
		88 - 93 3" M12	25	145200
		94 - 98 M12	25	414112
		102 - 108 M12	25	145228
		110 - 116 4" M12	25	145237
		124 - 129 M12	25	145255
		133 - 140 5" M16	10	145264
		149 - 155 M16	10	145273
		159 - 165 6" M16	10	145282
		167 - 173 M16	10	145291
		176 - 182 M16	10	145307
		188 - 194 M16	10	145316
		199 - 205 M16	10	145325
		210 - 219 8" M16	10	414193
		230 - 236 M16	10	414724
		247 - 253 M16	10	414679
	271 - 277 10" M16	10	414688	
	312 - 318 M16	10	414697	
	322 - 329 12" M16	10	414706	

Stran	Produkt	Artikel	Pakirano	Artikel-št.
16-9	Stabil D-1G VA z o.	Skupina: 1741		
		14 - 18 $\frac{3}{8}$ " M8	50	144856
		19 - 23 $\frac{1}{2}$ " M8	50	144865
		24 - 28 $\frac{3}{4}$ " M10	50	144874
		29 - 33 M10	50	144883
		33 - 37 1" M10	50	144892
		40 - 45 $1\frac{1}{4}$ " M10	50	144908
		47 - 52 $1\frac{1}{2}$ " M10	50	144917
		53 - 58 M10	50	144926
		60 - 65 2" M10	50	144935
		67 - 72 M12	25	144944
		73 - 78 $2\frac{1}{2}$ " M12	25	145088
		79 - 85 M12	25	144953
		86 - 90 3" M12	25	144962
		100 - 106 M12	25	144971
		108 - 115 4" M12	25	144980
		124 - 129 M16	25	144999
		131 - 137 M16	10	145006
		138 - 144 5" M16	10	145015
		148 - 154 M16	10	145024
		156 - 162 M16	10	145033
		165 - 171 6" M16	10	145042
		177 - 183 M16	10	145051
		188 - 194 M16	10	145060
		199 - 208 M16	10	414904
		219 - 225 8" M16	10	145079
		236 - 242 M16	10	414913
		260 - 266 M16	10	414922
		301 - 307 M16	10	414931
		311 - 318 M16	10	414940

Stran	Produkt	Artikel	Pakirano	Artikel-št.
16-10	Stabil D-1G VA Silikon	Skupina: 1743		
		14 - 18 $\frac{3}{8}$ " M8	50	145370
		19 - 23 $\frac{1}{2}$ " M8	50	145389
		24 - 28 $\frac{3}{4}$ " M10	50	145398
		29 - 33 M10	50	145404
		33 - 37 1" M10	50	145413
		40 - 45 $1\frac{1}{4}$ " M10	50	145422
		47 - 52 $1\frac{1}{2}$ " M10	50	145431
		53 - 58 M10	50	145440
		60 - 65 2" M10	50	145459
		67 - 72 M12	25	145468
		73 - 78 $2\frac{1}{2}$ " M12	25	145477
		79 - 85 M12	25	145486
		86 - 90 3" M12	25	145495
		100 - 106 M12	25	145501
		108 - 115 4" M12	25	145510
		124 - 129 M16	25	145529
		131 - 137 M16	10	145538
		138 - 144 5" M16	10	145547
		148 - 154 M16	10	145556
		156 - 162 M16	10	145565
		165 - 171 6" M16	10	145574
		177 - 183 M16	10	145583
		188 - 194 M16	10	145592
		199 - 208 M16	10	414508
		219 - 225 8" M16	10	145608
		236 - 242 M16	10	414517
		260 - 266 M16	10	414526
	301 - 307 M16	10	414535	
	311 - 318 M16	10	414544	
16-11	Adapter AD IG/IG VA	Skupina: 1733		
		M16/M12	25	170295
		M16/M16	50	170286

Stran	Produkt	Artikel	Pakirano	Artikel-št.
	Stabil D-2G/-3G VA	Skupina: 1740		
		18 – 22 2G	50	172568
		24 – 28 2G	50	172577
		30 – 34 2G	50	172586
		35 – 37 2G	50	172595
		40 – 44 2G	50	172604
		47 – 51 2G	50	172613
		54 – 58 2G	50	172622
		59 – 63 2G	50	172631
		67 – 71 2G	50	172856
		74 – 78 2G	25	172640
		81 – 85 2G	25	172865
		86 – 90 3G	25	172649
		94 – 98 3G	25	172874
		102 – 108 3G	25	173153
		108 – 114 3G	25	172658
		116 – 122 3G	25	172883
		133 – 140 3G	10	172667
		145 – 152 3G	10	172892
		159 – 169 3G	10	172676
		170 – 180 3G	10	172901
	198 – 207 3G	10	172685	
	210 – 219 3G	10	172694	
	222 – 231 3G	10	172910	
	Stabil D-2G/-3G z o. VA	Skupina: 1741		
		18 – 20 2G	50	172703
		21 – 24 2G	50	172712
		25 – 29 2G	50	172721
		31 – 35 2G	50	172730
		38 – 42 2G	50	172739
		46 – 50 2G	50	172748
		51 – 55 2G	50	172757
		58 – 63 2G	50	172766
		74 – 78 2G	25	172775
		86 – 90 3G	25	172784
		100 – 106 3G	25	173162
		108 – 114 3G	25	172793
		133 – 140 3G	10	172802
	158 – 168 3G	10	172811	
	198 – 207 3G	10	172820	
	210 – 219 3G	10	172829	

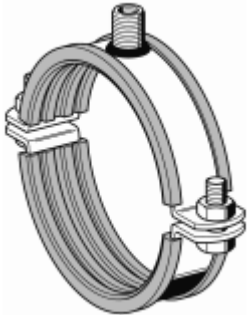
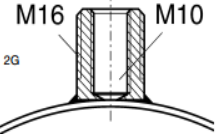
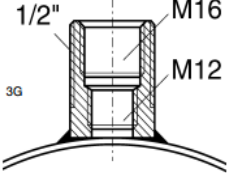
Stran	Produkt	Artikel	Pakirano	Artikel-št.
	Stabil D-2G/-3G Silikon VA	Skupina: 1743		
	  	18 – 20 2G	50	172919
		21 – 24 2G	50	172928
		25 – 29 2G	50	172937
		31 – 35 2G	50	172946
		38 – 42 2G	50	172955
		46 – 50 2G	50	172964
		51 – 55 2G	50	172973
		58 – 63 2G	50	172982
		74 – 78 2G	25	172991
		86 – 90 3G	25	173000
		100 – 106 3G	25	173072
		108 – 114 3G	25	173009
		133 – 140 3G	10	173018
		158 – 168 3G	10	173027
		198 – 207 3G	10	173036
	210 – 219 3G	10	173045	

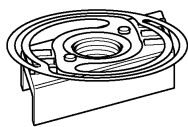
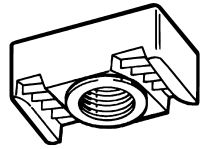
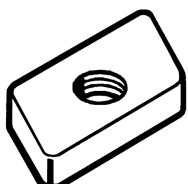
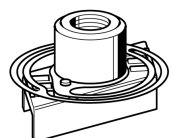

Stran	Produkt	Artikel	Pakirano	Artikel-št.	
16-12	Streme navojno RUB VA	Skupina: 1710			
		1/2" M 8	50	102719	
		3/4" M 8	50	102728	
		1" M 8	50	102737	
		1 1/4" M 8	50	102746	
		1 1/2" M 8	50	102889	
		2" M 10	50	102898	
		2 1/2" M 10	50	102904	
		3" M 10	50	102913	
		108 M 12	50	102922	
		4" M 12	25	102694	
		133 M 12	25	102685	
		5" M 12	25	102931	
		159 M 12	25	102940	
		6" M 12	10	102700	
	8" M 12	10	102959		
	10" M 20	10	102968		
16-13	Perforiran trak BND VA	Skupina: 1729			
		17 x 0,5	1	104623	
16-14	Montažni profil MS VA	Skupina: 1711			
		41/21/2,0 6 A4	6	110595	
		41/41/2,0 2 A4	2	195802	
		41/41/2,0 6 A4	6	195796	
		41/62/2,5 6 A4	6	173972	
		41/41/2,0 D 6 A4	6	195819	
		41/62/2,5 D 6 A4	6	174143	

Stran	Produkt	Artikel	Pakirano	Artikel-št.
16-15	Matica kljukasta NT CC 41 VA	Skupina: 1714		
		CC 41-M8	50	199305
		CC 41-M10	50	199312
				
16-16	Matica kljukasta NT HZ 41 VA	Skupina: 1714		
		HZ 41-M12	50	182342
		HZ 41-M16	50	182351
				
16-16	Matica navojna NT VA	Skupina: 1714		
		L 41-M8	100	159340
		L 41-M10	100	159359
		L 41-M16	25	406634
				
16-17	Adapter NT CC 41 DIN 3015 VA	Skupina: 1714		
		M6	100	110008
		M8	100	110017
		M10	100	110009
		M12	100	110010
				

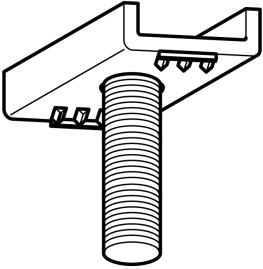
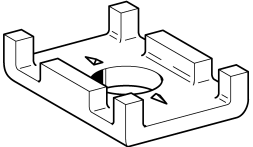
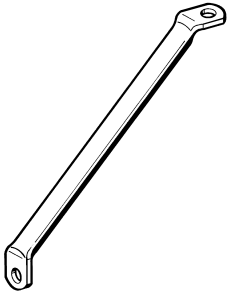
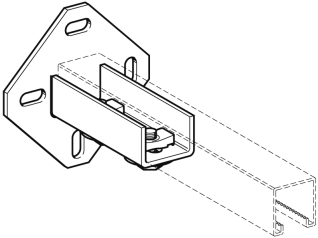

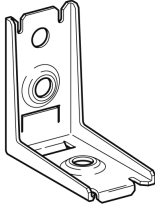
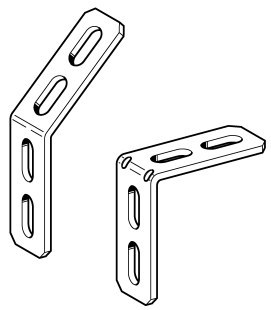
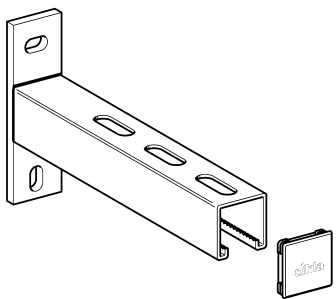
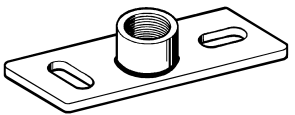
Stran	Produkt	Artikel	Pakirano	Artikel-št.
16-19	Vijak z kljukasto glavo HZ41	Skupina: 1707		
		HZ 41 M8 x 35	50	111455
		HZ 41 M10 x 35	50	111457
		HZ 41 M12 x 35	50	187454
16-20	Ozobje kljukasto HK VA	Skupina: 1728		
		41/10	50	178634
		41/12	50	178643
		41/16	50	178652
16-20	Opornik STR VA	Skupina: 1726		
		550/350	10	171920
16-21	WBD držalo VA	Skupina: 1730		
		41/41-62	5	193631
		41/41-41 D	1	436377

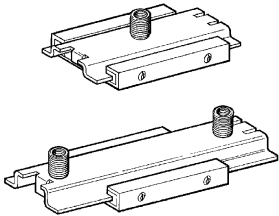
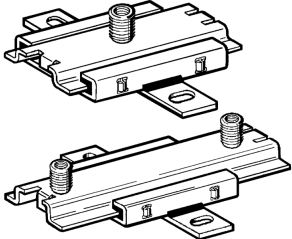
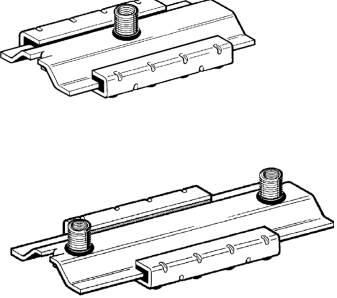
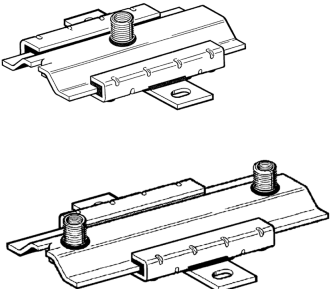
Stran	Produkt	Artikel	Pakirano	Artikel-št.
16-22	Kotnik MW 90° W Stabil VA	Skupina: 1726 90° W Stabil	25	191702
				
16-23	Montažni kotnik MW VA	Skupina: 1726 90/90/45° 95/95/90°	25 25	105721 106281
				
16-24	Previsna konzola AK VA	Skupina: 1754 41/41 - 200 41/41 - 260 41/41 - 320 41/41 - 445	10 10 10 10	115520 115539 115548 115557
				
16-25	Osnovna plošča GPL VA	Skupina: 1727 Normal M8 Normal M10 Normal M12 Stabil M12 Stabil M16	50 50 50 50 50	401773 401782 401791 107626 107635
				

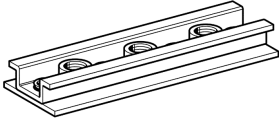
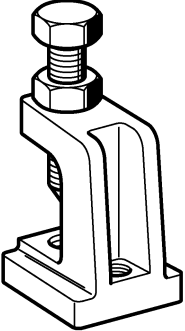
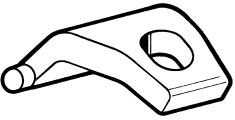
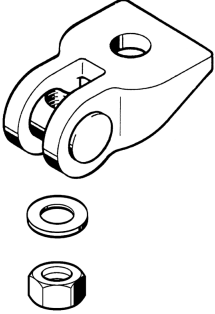
Stran	Produkt	Artikel	Pakirano	Artikel-št.
16-26	Drsnik GS 2G VA	Skupina: 1736		
		2G	25	170161
		2G2	25	170189
16-27	Drsnik GS 2G-PL VA	Skupina: 1736		
		2G-PL	25	170170
		2G2-PL	25	170198
16-28	Drsnik GS H3G VA	Skupina: 1736		
		H3G2	10	170125
		H3G	10	170143
16-29	Drsnik GS H3G-PL VA	Skupina: 1736		
		H3G-PL	10	170152
		H3G2-PL	10	170134

Stran	Produkt	Artikel	Pakirano	Artikel-št.
16-30	Drsnik GS 41 VA	Skupina: 1736 41 - M10	10	190667
				
16-31	Spona za nosilec TCS VA	Skupina: 1737 TCS 1 M10/M8 TCS 1 M10/M12	50 50	170231 110766
				
16-32	Vpenjalni nastavek P VA	Skupina: 1731 P2	25	163435
				
16-33	Zglob univerzalni UG VA	Skupina: 1742 UG M8 UG M10 UG M12 UG M16	50 50 25 25	171686 171695 171704 171713
				

Stran	Produkt	Artikel	Pakirano	Artikel-št.
16-34	Hanger vijak BSCR brez vezi VA	Skupina: 1715		
		M8 / 80	100	410836
		M10 / 100	100	410845
16-34	Šestrobi lesni vijak SKH VA	Skupina: 1770		
		8 x 60	200	411475
		8 x 80	100	411484
16-34	Šestrobi vijak SKT VA	Skupina: 1775		
		M6/25	100	104359
		M8/25	100	146131
		M8/35	100	104669
		M10/20	100	413176
		M10/30	100	104678
		M10/45	100	104377
		M12/30	100	151397
		M12/35	100	146140
		M12/50	100	104368
		M16/25	100	172280
		M16/30	100	172289
		M16/45	50	404968
		M16/50	100	151643

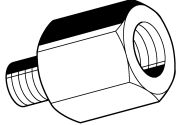
Stran	Produkt	Artikel	Pakirano	Artikel-št.
16-35	Podložka US VA	Skupina: 1772		
		8/40	100	111865
		8/125	100	104766
		8/9021	100	172019
		10/40	100	111866
		10/125	100	104775
		10/9021	100	171740
		12/40	100	111867
		12/125	100	104784
		16/125	100	104809
		16/9021	100	172028
16-35	Matica NT VA	Skupina: 1771		
		M6	100	104696
		M8	100	104702
		M10	100	104711
		M12	100	104720
		M16	100	104748
16-36	Podaljšek navojni AD IG/IG VA	Skupina: 1732		
		M8	100	104818
		M10	100	104827
		M12	50	104836
		M16	50	104845
16-36	Prehodni kos AD IG/AG VA	Skupina: 1713		
		12/8	50	113652
		12/10	50	113661

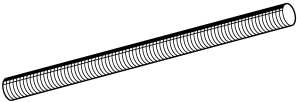
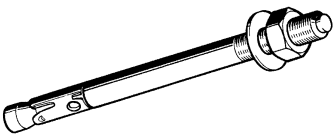
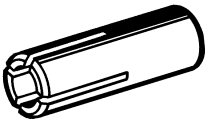
Stran	Produkt	Artikel	Pakirano	Artikel-št.	
16-37	Navojna palica GST VA	Skupina: 1717			
		M8 x 1000	1	104854	
		M10 x 1000	1	104863	
		M12 x 1000	1	104872	
		M16 x 1000	1	104881	
		M8 x 3000	1	172253	
		M10 x 3000	1	113914	
		M12 x 3000	1	113915	
		M16 x 3000	1	113916	
16-38	Sidro AN BZ plus A4	Skupina: 1704			
		8/5/50 A4*	100	110551	
		8/10/75 A4	100	110457	
		8/30/95 A4	100	110552	
		8/50/115 A4	100	110458	
		10/10/60 A4 *	50	110553	
		10/10/90 A4	50	110459	
		10/15/95 A4	50	110554	
		10/30/110 A4	50	110555	
		10/50/130 A4	50	110460	
		10/100/180 A4	50	110461	
		12/15/110 A4	25	110462	
		12/20/115 A4	25	110556	
		12/30/125 A4	25	110557	
		12/50/145 A4	25	110558	
		12/85/180 A4	25	110559	
		16/25/145 A4	20	110560	
		16/50/170 A4	20	110561	
16-40	Udarno sidro AN VA	Skupina: 1702			
		M8 x 30	100	104906	
		M8 x 40	100	153593	
		M10 x 40	50	104915	
		M12 x 50	50	104924	
		M16 x 65	25	104933	

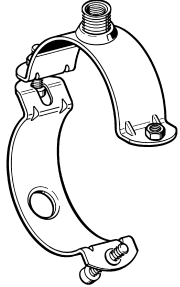
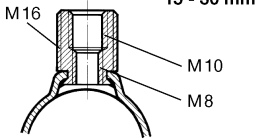
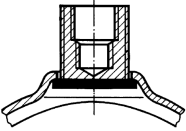
Stran	Produkt	Artikel	Pakirano	Artikel-št.
	<p>Stabil D-3G HCP</p>  <p>15 - 30 mm</p>  <p>M16 M10 M8</p> <p>31 - 72 mm: M16/M10/M8 76 - 129 mm: ¾"/M12/M10 133 - 316 mm: ½"/M16/M12</p> 	<p>Skupina: 1844</p> <p>15 - 18 $\frac{3}{8}$"</p> <p>20 - 24 $\frac{1}{2}$"</p> <p>25 - 30 $\frac{3}{4}$"</p> <p>31 - 35 1"</p> <p>40 - 45 $1\frac{1}{4}$"</p> <p>48 - 53 $1\frac{1}{2}$"</p> <p>54 - 59</p> <p>60 - 65 2</p> <p>67 - 72</p> <p>76 - 81 $2\frac{1}{2}$"</p> <p>82 - 87</p> <p>88 - 93 3"</p> <p>102 - 108</p> <p>110 - 116 4"</p> <p>124 - 129</p> <p>133 - 140</p> <p>140 - 148 5"</p> <p>149 - 155</p> <p>159 - 165</p> <p>167 - 173 6"</p> <p>176 - 184</p> <p>188 - 194</p> <p>199 - 205</p> <p>207 - 216</p> <p>219 - 225 8"</p> <p>244 - 250</p> <p>267 - 273 10"</p> <p>278 - 284</p> <p>297 - 303</p> <p>310 - 316</p>		
			50	112216
			50	112217
			50	112218
			50	112219
			50	112220
			50	112221
			50	112222
			50	112223
			50	112224
			25	112225
			25	112226
			25	112227
			25	112228
			25	112229
			25	112230
			10	112231
			10	112232
			10	112233
			10	112234
			10	112235
			10	112236
			10	112237
			10	112238
			10	112239
			10	112240
			10	112242
			10	112244
			10	112245
			10	112246
			10	112247

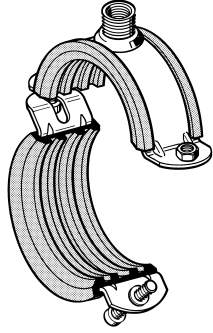
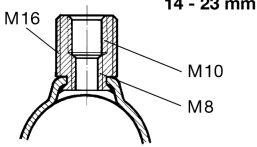
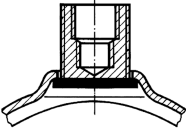
Stran	Produkt	Artikel	Pakirano	Artikel-št.
	Stabil D-3G z o. HCP	Skupina: 1843		
	  <p>14 - 23 mm</p> <p>M16 M10 M8</p>  <p>24 - 65 mm: M16/M10/M8 67 - 115 mm: 3/8"/M12/M10 124 - 318 mm: 1/2"/M16/M12</p>	18 $\frac{3}{8}$ "	50	112249
		19 - 23 $\frac{1}{2}$ "	50	112250
		24 - 28 $\frac{3}{4}$ "	50	112251
		29 - 33 1"	50	112252
		33 - 37	50	112253
		40 - 45 $1 \frac{1}{4}$ "	50	112254
		47 - 52 $1 \frac{1}{2}$ "	50	112255
		53 - 58	50	112256
		60 - 65 2"	25	112257
		67 - 72	25	112258
		73 - 78 $2 \frac{1}{2}$ "	25	112259
		79 - 85	25	112260
		88 - 93 3"	25	112261
		100 - 106	25	112264
		108 - 115 4"	25	112265
		124 - 129	10	112266
		131 - 137	10	112267
		138 - 144 5"	10	112268
		148 - 154	10	112269
		156 - 162	10	112270
		165 - 171 6"	10	112271
		177 - 183	10	112272
		188 - 194	10	112273
		196 - 203	10	112274
		205 - 214	10	112275
		219 - 225 8"	10	112276
		244 - 250	10	112278
		267 - 273 10"	10	112280
		278 - 284	10	112281
		299 - 305	10	112282
	207 - 318	10	112283	

Stran	Produkt	Artikel	Pakirano	Artikel-št.
	Stabil D-1G HCP	Skupina: 1840		
		15 - 19 $\frac{3}{8}$ " M10	50	169130
		20 - 24 $\frac{1}{2}$ " M10	50	169149
		25 - 30 $\frac{3}{4}$ " M10	50	169158
		31 - 35 1" M10	50	167208
		40 - 45 $1\frac{1}{4}$ " M10	50	167226
		48 - 53 $1\frac{1}{2}$ " M10	50	167235
		54 - 59 M10	50	163666
		60 - 65 2" M10	50	163675
		67 - 72 M10	50	163684
		76 - 81 $2\frac{1}{2}$ " M10	25	163693
		82 - 87 M10	25	163709
		88 - 93 3" M10	25	163718
		102 - 108 M10	25	163727
		110 - 116 4" M10	25	163736
		124 - 129 M12	25	163745
		133 - 140 M12	10	163754
		140 - 148 5" M12	10	163763
		149 - 155 M12	10	163772
		159 - 165 M12	10	163781
		167 - 173 6" M12	10	163790
		176 - 184 M12	10	163806
		188 - 194 M12	10	163815
		199 - 205 M12	10	163824
		207 - 216 M12	10	163833
		219 - 225 8" M12	10	163842
		244 - 250 M12	10	163851
		267 - 273 10" M12	10	163860
		278 - 284 M12	10	163879
	297 - 303 M12	10	163888	
	Cevna zanka RSL N HCP	Skupina: 1815		
		26,9 $\frac{3}{4}$ " M8 (VdS)	100	113242
		33,7 1" M8 (VdS)	100	113243
		42,4 $1\frac{1}{4}$ " M8 (VdS)	50	113244
		48,3 $1\frac{1}{2}$ " M8 (VdS)	50	113245
		60,3 2" M8 (VdS)	50	113246
		26,9 $\frac{3}{4}$ " M10 (FM)	100	113415
		33,7 1" M10 (FM)	100	113238
		42,4 $1\frac{1}{4}$ " M10 (FM)	50	113239
		48,3 $1\frac{1}{2}$ " M10 (FM)	50	113240
		60,3 2" M10 (FM)	50	113241
		76,1 $2\frac{1}{2}$ " M10	25	113247
		88,9 3" M10	25	113248
		108 M10	25	113249
		114.3 4" M10	25	113250
		133 M12	25	113251
		139.7 5" M12	25	113252
		159 M12	25	113253
		168.3 6" M12	25	113254
		219.1 8" M16	10	113255

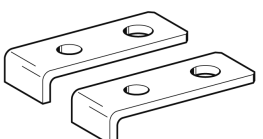
Stran	Produkt	Artikel	Pakirano	Artikel-št.	
17-5	Cevna objemka RB-A HCP	Skupina: 1860			
		13-18	25	112790	
		17-22	25	112791	
		23-27	25	112792	
		30-34	25	112793	
		34-38	25	112794	
		40-44	25	112795	
		45-49	25	112796	
		57-61	25	112797	
		66-70	25	112798	
		73-77	25	112799	
		85-89	25	112800	
		90-104	10	112801	
		103-109	10	112802	
		109-115	10	112803	
		119-133	10	112804	
		134-140	10	112805	
		156-162	10	112806	
		163-169	10	112807	
		188-194	1	112808	
		214-220	1	112809	
		248-254	1	112810	
		261-267	1	112811	
		265-273	1	112812	
		316-324	1	112813	
		350-356	1	112814	
		360-368	1	112815	
		402-407	1	112816	
		412-419	1	112817	
		450-457	1	112818	
		501-508	1	112819	
		512-521	1	112820	
		529-535	1	112821	
		603-610	1	112822	
17-6	Pritrditev za streme HCP	Skupina: 1810			
		UBF	25	194188	

Stran	Produkt	Artikel	Pakirano	Artikel-št.
17-7	Navojno streme DIN 3570 A HCP	Skupina: 1810		
		1/2" M 10	100	404662
		3/4" M 10	50	162179
		1" M 10	50	162188
		1 1/4" M 10	50	162197
		1 1/2" M 10	50	162203
		2" M 12	50	162212
		2 1/2" M 12	50	162221
		3" M 12	50	162230
		4" M 16	25	162249
		5" M 16	25	162258
		6" M 16	10	162267
		202 M 16	10	162276
		8" M 20	10	162285
		10" M 20	10	162294
		12" M 20	1	162300
		378 M 24	1	162319
		428 M 24	1	162328
	530 M 24	1	162337	
17-8	Montažni profil MS 41 HCP	Skupina: 1811		
		41/21/2,0 6	6	193860
		41/31/2,0 6	6	198896
		41/41/2,0 6	6	196724
		41/41/2,5 6	6	161497
		41/62/2,5 6	6	199527
		41-75/75/3,0 6	6	174008
		41/21/2,0 D * 6	6	193884
		41/41/2,5 D * 6	6	166748
		41-75/75/3,0 D *6	6	173981
17-10		Matica kljukasta NT CC 41 HCP	Skupina: 1814	
		CC 41-M6	50	198698
		CC 41-M8	50	198650
		CC 41-M10	50	186284
		CC-41 M12	50	110015

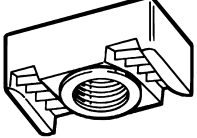
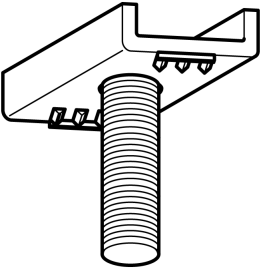
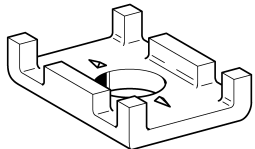
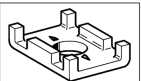
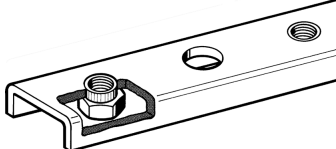

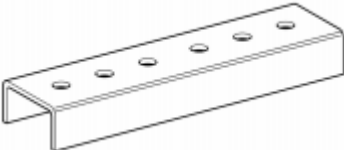
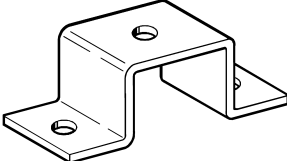
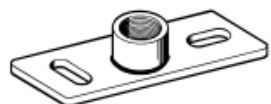
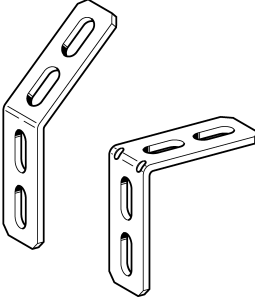
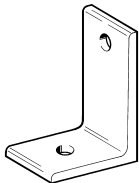
Stran	Produkt	Artikel	Pakirano	Artikel-št.
17-11	Matica kljukasta NT HZ 41 HCP	Skupina: 1814		
		HZ 41-M10	50	162115
		HZ 41-M12	50	162133
		HZ 41-M16	50	182279
17-12	Vijak s kljuk. glavom HZ 41 HCP	Skupina: 1809		
		HZ 41 M10 x 35	50	111453
		HZ 41 M12 x 35	50	111454
17-13	Ozobje kljukasto HK HCP	Skupina: 1828		
		41/10	50	179606
		41/12	50	179615
		41/16	50	179624
17-14	Sklop za profile SK HCP	Skupina: 1853		
	 2x	SK 41/21-31	10	186680
		SK 41/41-45	10	195642
		SK 41-75/75	10	195680

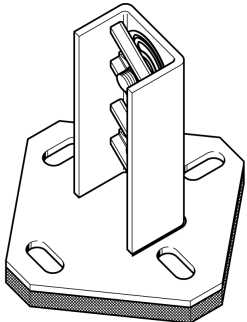
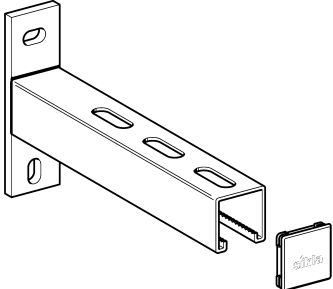
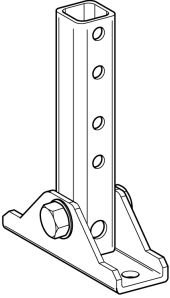
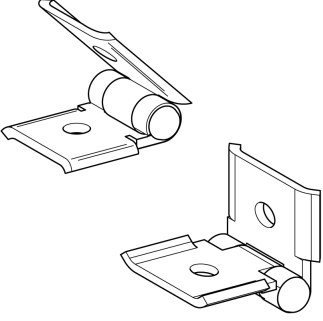

Stran	Produkt	Artikel	Pakirano	Artikel-št.
17-15	Sklop za profile SK-L HCP	Skupina: 1853		
		SK-L	10	198971
17-16	Držalo profila SH HCP	Skupina: 1812		
		SH 41/21	50	189992
		SH 41/41	50	183116
		SH 41/41 D	10	183143
		SH 41/45	50	183125
		SH 41/45 D	10	183152
		SH 41-75/75	25	183134
	Osnovna plošča GPL HCP	Skupina: 1827		
		Stabil M10	50	112684
		Stabil M12	50	112685
		Stabil ;16D	50	112686
		Stabil 1/2"	50	112683
17-17	Montažni kotnik MW HCP	Skupina: 1826		
		90/90/30°	25	194041
		90/90/45°	25	162045
		95/95/90°	25	162036
17-18	Montažni kotnik MW S HCP	Skupina: 1826		
		60/40/90°	25	162063
		90/60/90°	25	162072

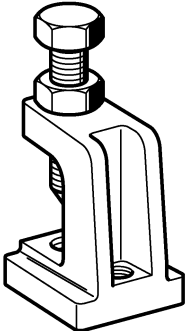
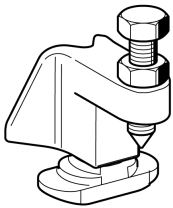
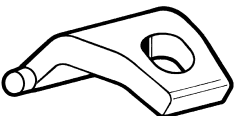
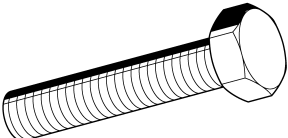
Stran	Produkt	Artikel	Pakirano	Artikel-št.
17-19	Kotna konzola WK HCP	Skupina: 1826		
		100/100-40	25	163930
		150/150	25	181685
		300/200	1	162531
		550/350	1	162610
17-20	WBD Držalo HCP	Skupina: 1856		
		41/21-31	10	198063
		41/41-45	10	198070
		41/41-45 D	5	198100
17-21	WBD držalo C HCP	Skupina: 1856		
		41/41-45 C0	1	179498
		41-75/75 C0	1	179507
		41/41-45 D C0	1	179561
		41-75/75 D C1	1	179579
		41-75/75 D C2	1	179588

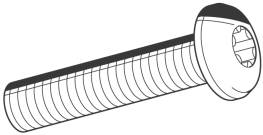
Stran	Produkt	Artikel	Pakirano	Artikel-št.
17-22	Držalo SHB HCP 	Skupina: 1856		
		SHB 41-1	10	198902
		SHB 41-2	5	198919
		SHB 160	10	112163
		SHB 300	1	112164
		SHB 450	1	112167
		SHB 600	1	112165
				112166
17-23	Previsna konzola AK HCP 	Skupina: 1854		
		41/41 - 320	10	181667
		41/41 - 570	10	181676
		41/41 - 820	1	161479
		41/62 - 320	10	180119
		41/62 - 570	10	180128
		41/62 - 820	1	180137
		41/21 D - 320	10	180146
		41/21 D - 570	10	180155
		41/21 Dq - 320	10	180164
		41/21 Dq - 570	10	190424
17-24	Zglob JOI 41 T HCP 	Skupina: 1842		
		JOI 41 T	20	197615
17-25	Zglob JOI 41 HCP 	Skupina: 1842		
		JOI 41 V	50	198049
		JOI 41 Z	50	199244

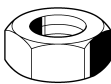
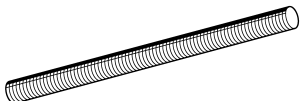
Stran	Produkt	Artikel	Pakirano	Artikel-št.
17-26	Spona za nosilec TCS HCP	Skupina: 1837		
		TCS 1 M10	50	162151
17-27	Spona za nosilec TCS 41 HCP	Skupina: 1837		
		TCS 41	50	110003
17-28	Vpenjalni nastavek P HCP	Skupina: 1831		
		P2	25	165905
		P3	25	165914
17-29	Šestrobi vijak SKT HCP	Skupina: 1870		
		M10/25	100	162568
		M10/40	100	162577
		M12/25	100	162586
		M12/30	100	164144
		M12/40	50	162595
		M12/60	50	164153
		M12/80	50	164162
		M12/100	50	164171
		M16/50	100	162601
		M16/80	25	164180
		M16/100	25	171866

Stran	Produkt	Artikel	Pakirano	Artikel-št.
17-30	Vijak SCR FLA HCP 	Skupina: 1875		
		M10 x 15	100	199107
		M10 x 25	100	198353
		TT M10 x 25	600	110503
		TT M10 x 55	500	197608
17-31	Podložka US HCP 	Skupina: 1872		
		10/125	100	162346
		12/125	100	162355
		16/125	100	179156
		10/40	100	162373
17-31	Matica NT HCP 	Skupina: 1871		
		M10	100	162391
		M12	100	162382
		M16	100	163019
17-31	Navojni zatič GST HCP 	Skupina: 1816		
		M10/40	100	162407
		M10/70	100	162416
		M10/110	100	162425
		M10/1000	25	167244
		M12/70	100	162443
		M12/110	100	162452
		M12/200	100	162461
		M12/250	100	180686
		M12/300	100	180695
		M12/400	100	180713
		M12/1000	25	189866
		M16/1000	10	192377

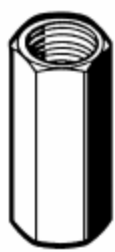
Stran	Produkt	Artikel	Pakirano	Artikel-št.
	Navojna cev GR HCP	Skupina: 1813 G ¹ / ₂ "	2m	110717
				
	Protimatica NT G HCP	Skupina: 1813 G ¹ / ₂ "	25	110755
				
	Podaljšek AD IG/IG HCP	Skupina: 1333 ¹ / ₂ " / M10 ¹ / ₂ " / M12 ¹ / ₂ " / M16 ¹ / ₂ " / ³ / ₈ " ¹ / ₂ " / ¹ / ₂ "	10 10 25 25 10	112163 112164 112167 112165 112166
				



Management Service

ZERTIFIKAT

Die Zertifizierungsstelle
der TÜV SÜD Management Service GmbH

bescheinigt, dass das Unternehmen

Sikla GmbH

In der Lache 17

D-78056 Villingen-Schwenningen

für den Geltungsbereich

Entwicklung, Herstellung und Vertrieb von
Systemen zur Befestigung und Verbindung von
Rohren sowie zur Dachentwässerung in der technischen
Gebäudeausrüstung und im Anlagenbau

einschließlich der
Standorte und Geltungsbereiche
gemäß Anlage

ein Qualitätsmanagementsystem
eingeführt hat und anwendet.

Durch ein Audit, Bericht-Nr. 70019146

wurde der Nachweis erbracht, dass die Forderungen der

ISO 9001:2008

erfüllt sind. Dieses Zertifikat ist gültig bis **2015-07-12**

Zertifikat-Registrier-Nr. **12 100 3158 TMS**

München, 2012-07-18

Seite 1 von 2



QMS-TGA-ZM-07-92

1. Splošno: Sledeči pogoji so edini merodajni pogoji za celotno poslovanje, tudi takrat, kadar je naročnik uradno določil drugačne pogoje. Veljajo za sprejete s strani kupca, v kolikor kupec pri naročilu ni ugovarjal. Telefonska ali ustna dopolnila oz. spremembe potrebujejo za veljavnost naše pisno potrditev. Vsi dosedanji prodajni pogoji so s tem neveljavni.

2. Naše ponudbe so, če ni drugačnega dogovora, neobvezne. Za slike in risbe v naših katalogih, kakor tudi pri naših vzorcih si pridržujemo lastniško in avtorsko pravico. Brez našega dovoljenja ne smejo biti dostopne tretjim osebam in jih je potrebno na zahtevo nemudoma vrniti.

Mere in tehnični podatki:

Vse navedena mere in tehnični podatki imajo približne vrednosti. Za upoštevanje ne prevzemamo nobene odgovornosti. Pridržujemo si pravico do sprememb.

3. Cene v EUR veljajo franko podjetje oz. Podružnica brez embalaže in z dodanim DDV. Obračunajo se cene, veljavne na dan dobave. Pridržujemo si pravico do spremembe cen.

4. Dobava: Navedeni dobavni roki pričnejo veljati z dnem potrditve naročila in so neobvezujoči. Reklamacije, ki so nastale zaradi zavračevanja dobavnih rokov, ki so nastali zaradi motenj v podjetju, nepredvidenih težav pri dobavi surovin in obratnih sredstev oz. Zaradi višje sile, se ne priznajo. Izključuje se možnost odstopa od dobave. Delne dobave so dopustne na stroške naročnika. Pri napisnih tablah za gradbišča in samolepilnih folijah lahko pride do preseganja naročne količine za 10 %, ker gre za izdelavo po posebnem naročilu, mora naročnik prevzeti in plačati presežek.

5. Sukcesivne dobave, v kolikor to ni v potrdilu naročila drugače določeno, morajo biti prevzete v roku štirih mesecev po zaključku naročila, ne da bi z naše strani prišla zahteva za prevzem. V kolikor je ta rok prekoračen, si pridržujemo pravico blago zaračunati, ali stornirati naročilo.

6. Odprema se vedno izvrši na račun in riziko naročnika. Kadar se ne navedejo odpremni pogoji, se vedno izbere najugodnejša transportna pot, brez odgovornosti za najcenejše pošiljanje ali dostetje blaga v dobrem stanju. Razlika je le pri odpremi blaga v vrednosti najmanj EUR 370,-- , kjer velja pariteta fco sprejemna postaja.

7. Embalaža se zaračuna po lastni nabavni ceni. Vsa uporabljena embalažna sredstva, kot so lepenka, zaboji za enkratno uporabo iz vezanih plošč ali običajni leseni zaboji so nepovratna.

8. Plačilo: Naši računi so plačljivi v roku 30 dni od dneva izstavitve računa neto (ne po datumu prejema računa ali blaga). Pri plačilu v roku 10 dni od dneva izstavitve računa priznamo 3 % skonto na vrednost računa, pod pogojem, da so vse zapadle fakture poravnane. Plačilni rok je izpolnjen, če je nakazilo ali s čekom plačan znesek v roku knjižen v dobro na enem naših bančnih

računov. Menic, kot plačilnega sredstva, ne sprejemamo. Pri mednarodnih plačilih grede bančni stroški za izvršitev nakazila doma na naš račun in stroški v tujini na račun zavezanca za plačilo. Večkratni skonto odbitki oz. skonto odbitki po roku plačila, kot tudi zmanjšanje stroškov pošiljanja in embalaže, se ne priznavajo. Pri zamudi rokov plačil se zaračunavajo običajne bančne zamudne obresti. V kolikor zapadli računi kljub opominu niso poravnani, zapadejo v plačilo vsi odprti računi. Razen tega si pridržujemo pravico do popolne ali delne ukinitve količinskega popusta. Nepoznanim kupcem lahko v začetku dobavljamo blago le proti plačilu v gotovini, po povzetju ali predplačilu s 3 % skantom. Smatra se za dogovorjeno, da nosi stroške pri zamudi plačila ali izvensodne inkaso stroške in stroške opominov s strani odvetnika, naročnik blaga.

9. Zgoraj omenjeni dobavni in plačilni pogoji veljajo v primeru vašega naročila, kot sporazumno dogovorjeni, tudi če so vaši pogoji ob naročilu drugačni. Razveljavijo se lahko delno ali v celoti le, če se pismeno sporazumemo drugače.

10. Pridržanje pravice do lastništva: Dobavljeno blago ostaja naša last do popolnega plačila oz. do vnovčitve čeka, tudi pri ponovni prodaji. Zastava ali dajanje v varščino nista dovoljena. Kupec nas je dolžan nemudoma obvestiti o pričakovani ali izvršeni izvržbi oz. ob vsakem kratenju naših pravic s strani tretje osebe. Po stečajnem pravilniku imamo pravico na izločitev oz. odstop naše pravice na poplačilo.

V primeru prevzema z naše strani dobavljenega blaga s pridržano lastninsko pravico, s strani tretje osebe, nas mora naročnik o tem nemudoma obvestiti. Morebitni stroški za potrebno intervencijo napram tretji osebi gredo v breme naročnika.

11. Reklamacije glede kakovosti pošiljke je potrebno sporočiti najpozneje v roku 5 dni po prejemu pošiljke. V nasprotnem primeru se smatra pošiljka kot sprejeta. Naša obveza se omejuje na naknadno dobavo blaga ali dobropis za blago. Za izdelke tujih proizvajalcev jamčimo načelno le v obsegu, za katerega jamčijo in prevzemajo obveznosti tudi naši poddobavitelji. Morebitno vračilo pošiljke brez predhodnega dogovora s prodajalcem ni dovoljeno. V kolikor gre pri tem za delne pošiljke, se obravnavano naročilo iz tega razloga ne more anulirati. Pri ugovorih zaradi količine je na splošno veljaven.

12. Garancija oz. garancijski rok: garancijski rok znaša načeloma 24 mesecev od dneva nakupa za brezhibno kvaliteto blaga, izvedbo in delovanje pod pogoji, da prvič blago pred predelavo oz. uporabo ni bilo izpostavljeno škodljivim vplivom in drugič, da je bila predelava ali montaža izvedena primerno stanju tehnike.

13. Vračilo blaga: Načeloma se ne sprejme pravilno dobavljeno in prodano blago. Izjeme so možne samo v določenih, dogovorjenih primerih. V kolikor smo zaradi kulantnosti pripravljene sprejeti vrnjeno blago, se odbije naročniku 10 % stroškov za ponovno skladiščenje blaga. Pošiljka mora biti vrnjena brez stroškov. Blago mora biti dobro zapakirano. Dodelave, ki bi bile potrebne zaradi slabega pakiranja ali drugih vplivov, se zaračunajo po lastni ceni. Pri posebnih izdelavah, ki jih ni mogoče

prodati naprej, je vračilo blaga izključeno.

14. Kraj izpolnitve za vse posle, kakor tudi za vse ostale pravice in obveznosti, ki izhajajo iz posla je Črenšovci oz. za dobave in plačila Črenšovci. Pristojno sodišče v obeh primerih je Črenšovci.

Ignac Jantelj
Direktor podjetja

Sikla d.o.o.

Prekmurske čete 74

9232 Črenšovci

Telefon +386 (0)2 573 58 62 – centrala

Telefaks +386 (0)2 573 58 71

E-mail: info@sikla.si

Internet: www.sikla.si